

Go Beyond Normal Limits...SM

RITRON[®]
WIRELESS SOLUTIONS

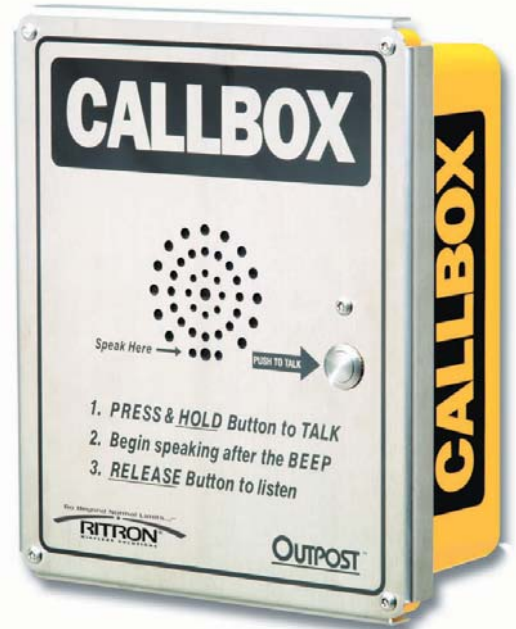
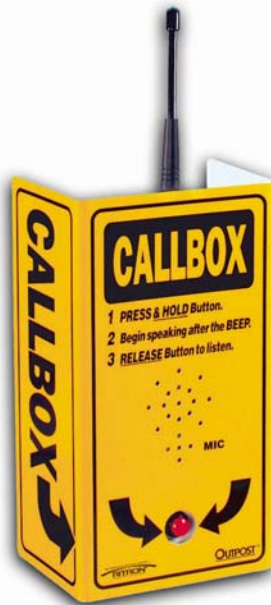

Series OUTPOST[®] Owner's Manual

- For Serial #'s 13250 or Higher – Use Ritron Pub No. 14500056 – “1” Series Owners Manual.
- For Serial #'s 13249 or Lower – Use Ritron Pub No. 14500048 – “1” Series Owners Manual.



Ritron Pub. 14500056

Rev. C

07/12

© 2005-2012 Ritron, Inc. All rights reserved. Ritron, Patriot, Jobcom, OutPost, GateGuard, Quiet Call and Quick Assist are registered trademarks of Ritron, Inc. Quick Talk, Liberty and RadioNexus are trademarks of Ritron, Inc.

Basic Operation	1 SERIES OUTPOST® CALLBOX MODELS	1
	ABOUT THE 1 SERIES OUTPOST® CALLBOX	1
	OPTIONAL ACCESSORY EQUIPMENT.....	2
	OPERATING THE 1 SERIES OUTPOST® CALLBOX WITH FACTORY DEFAULT SETTINGS	2
	2013 FCC NARROWBAND MANDATE	3
	EXPOSURE TO RADIO FREQUENCY ENERGY	3
Installation Instructions	APPLYING POWER TO THE OUTPOST® CALLBOX	4
	FIG-1: Charge Jumper Shown in Charge Position.....	4
	POWER MANAGEMENT OPTIONS.....	5
	CALLBOX CONTROLS AND CONNECTORS	6
	FIG-2: Callbox Assembly, Controls and Connectors.....	6
	FIG-3: XT CALLBOX ASSEMBLY.....	7
	<u>BASIC</u> OUTPOST® INSTALLATION INSTRUCTIONS.....	8
	COVERAGE	8
	<u>XT</u> OUTPOST® INSTALLATION INSTRUCTIONS	8
	FIG-4: XT Callbox Mounting Tabs	8
	OPTIONAL <u>XT</u> OUTPOST® MOUNTING BRACKET INSTALLATION INSTRUCTIONS.....	9
FIG-5: Optional XTMK Mounting Bracket for XT Callbox	9	
HOW TO SEAL THE ANTENNA.....	9	
Field Programming	HOW TO READOUT CURRENT RADIO FREQUENCY & TONE CODES.....	10
	HOW TO FIELD PROGRAM FREQUENCY & TONE CODES	11
	TABLE 1: PROGRAMMABLE FREQUENCY CODES	12
	CANADIAN FREQUENCY CODES	12
	TABLE 2: INTERFERENCE ELIMINATOR PROGRAMMABLE QC TONE CODES.....	13
	TABLE 3: INTERFERENCE ELIMINATOR PROGRAMMABLE DQC TONE CODES	13
	HOW TO FIELD PROGRAM RADIO FEATURE CODES	14
	TABLE 4: SINGLE DIGIT RADIO FEATURE CODES	14
TABLE 5: ADVANCED FEATURE CODES	15	
Programmable Features	PROGRAMMABLE OUTPOST® CALLBOX FEATURES.....	16
	Glossary of Terms.....	16
	INTERCOM (ALWAYS-ON) PROGRAMMING.....	17
Licensing	FCC Licensing	18
	How to Obtain an FCC Radio License	18
	Safety Standards	18
	INDUSTRY CANADA Regulations.....	18
	Service.....	18
Warranty	RITRON, INC. LIMITED WARRANTY.....	19

Note: The “6” Series OUTPOST® Callbox features that are not available on the 1 Series include:
 Relay Control • Relay Outputs • 2-Tone Decode • Sensor Inputs • DTMF ANI • Companding • Listen In

THANK YOU FOR CHOOSING RITRON

Congratulations on your purchase of the OUTPOST® Callbox. Your new radio is the result of Ritron’s 30+ years of designing, manufacturing, and supplying reliable, professional wireless communication products. Ritron wireless products will improve the operation, safety, and profitability of any organization by providing instant voice communications between employees throughout the workplace.

1 SERIES OUTPOST® CALLBOX MODELS.....

VHF Models

RQX-151	VHF Basic Callbox
RQX-151-XT	VHF Vandal-Resistant XT Callbox

UHF Models

RQX-451	UHF Basic Callbox
RQX-451-XT	UHF Vandal-Resistant XT Callbox

VHF radios are designed to operate within the 15 MHz band between factory standard 150 and 165 MHz.

UHF radios are designed to operate within the 20 MHz band between factory standard 450 and 470 MHz.

The model number appears on the serial label located behind the removable faceplate of the basic Callbox enclosure. On XT models the model number is located on the bottom of the fiberglass reinforced vandal-resistant enclosure.

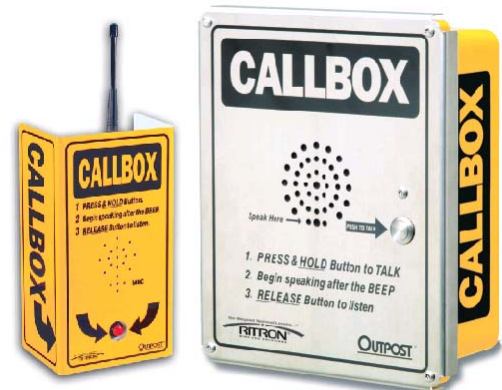

Basic Callbox

XT Callbox

ABOUT THE 1 SERIES OUTPOST® CALLBOX

The 1 Series OUTPOST® Callbox is a 2-way radio transceiver used to communicate directly with portable, mobile and stationary radios; or through radio repeaters with Ritron PC Programming software. Each callbox is equipped with the following features or capabilities

- **Field Programming.** Field programming allows you to quickly program your radio in the field without the need for a PC programmer. Each radio can be field programmed to one of 26 VHF or 77 UHF channel table frequencies, and one of 50 QC or 104 DQC interference eliminator codes.
- **VHF “License Free” Frequencies.** VHF models can be programmed from a list of 5 MURS frequencies that do not require FCC licensing.
- **154 Interference Eliminator Codes.** Quiet Call (QC) and Digital Quiet Call (DQC) codes can be programmed to eliminate other radio users not in your workgroup. For compatibility, new radios should be programmed with the same codes.
- **Wide or Narrow Band Operation.** The radio can be programmed for wide or narrow operation by selecting from a variety of field programmable table frequencies, or custom frequencies via special Ritron PC programming software by the factory or your Ritron dealer. Refer to the section [2013 FCC Narrowband Mandate](#) to see if your radio is capable of wideband transmit operation.
- **Volume Level.** Field programmable to any one of 5 preset levels and PC programmable to 2 – 100% volume level.
- **High/Low Power Output.** The callbox can be field programmed for transmitter power output.
 - **VHF:** 1 Watt
 - **UHF:** 1 Watt or 2* Watt
 - * See “Special Note” on page 4
- **Normal or High Microphone Gain.** Field and PC programmable to normal or high microphone gain.
- **Battery Powered.** The OUTPOST® Callbox is powered by 6 Alkaline, D-cell batteries that can operate the radio for up to one year or 7,000 transmissions.
- **External Power +12 VDC Capable.** The Basic and XT models are capable of being power by an external +12 VDC source. This method of powering the callbox allows the radio to remain **ON** at all times, like an intercom. Automatic Turn Off must be **DISABLED** via Field or PC programming for Intercom operation.
- **Low Battery Alert.** The callbox will transmit an Alert Tone at the end of each transmission when the batteries approach end-of-life. This allows sufficient time for you to replace the batteries and assure uninterrupted service.
- **+12 VDC Power Fail Alert.** This feature can be enabled via Field or PC programming. The callbox will transmit an Alert Tone if it detects loss of +12 VDC power. This Alert Tone replaces a Low Battery Alert. The radio automatically continues to transmit an Alert Tone once every hour (unless programmed for Automatic Turn Off) until +12 VDC is restored or the batteries are depleted.
- **“Automatic Turn-Off” or “Intercom” Operation.** The 1 Series OUTPOST® Callbox can operate in the standard “Automatic Turn-Off” mode (Factory Default), where the radio is normally **OFF** until the Call Button is pressed, or can be Field or PC programmed for “Intercom” operation where the radio is always **ON**. See “External Power +12 VDC Capable” feature above.
- **DTMF or Selcall ANI.** 1-9 digit DTMF or 3-7 digit Selcall codes can be transmitted at the beginning of each message for radio identification.

OPTIONAL ACCESSORY EQUIPMENT

Several options are available for the Ritron 1 Series OUTPOST® Callbox. These options, individually, or in combination with one another can greatly enhance the functionality of the callbox as well as the overall communication system. Available options include:

- **RSS-100** - The RSS-100 is a complete solar power supply system consisting of a 10-watt solar panel, charge controller and 8 AH rechargeable battery all housed in a rugged, ready-to-mount enclosure.
- **RCIM-1000** - The RCIM-1000 MDC-1200 encoder board allows each callbox to be assigned a unique unit ID number.
- **GGT-1F** - The GGT-1F DTMF decoder/relay board allows remote control of the on-board relay (e.g. Gateguard® operation) with a DTMF keypad equipped radio.
- **RQX-XTMK** – The RQX-XTMK is a mounting plate used to mount the XT callbox to most flat surfaces.
- **RQX-XTMK-GN** – The RQX-XTMK-GN is a mounting bracket used to mount the XT callbox to an industry standard gooseneck post.

For additional information and pictures of these items go to <http://www.ritron.com/callboxes.html> and download pdf of the product brochure.



RSS-100



RQX-XTMK-GN

OPERATING THE 1 SERIES OUTPOST® CALLBOX WITH FACTORY DEFAULT SETTINGS

The 1 Series OUTPOST® Callbox Factory Default setting is with Automatic Turn Off **ENABLED**. This means the callbox is **OFF** and will not receive a call until the callbox first initiates a call.

In Automatic Turn Off mode the callbox automatically shuts off whenever there is “no activity” for ten (10) seconds.

To Initiate a Call

Press and hold the **ON/PTT** Button. The callbox will send a unique **CALL TONE** to alert radio equipped personnel. This **CALL TONE** will also be heard at the callbox. Listen for the “beep”, then, begin speaking into the MIC. For best communication, the caller should be 3 feet or less from the microphone.

To Receive a Call

1. When you have finished speaking, release the **ON/PTT** Button.
2. Any reply will be heard through the callbox speaker. If a call is not received within 10 seconds of releasing the **ON/PTT** Button and there is no activity on the channel, the callbox will sound a low double tone and turn-off automatically. This automatic turn-off feature is designed to conserve battery life.

Operation Notes

The 1 Series OUTPOST® must be powered with D-cell Alkaline batteries **ONLY**, or alternatively, with an external 12 VDC power supply, order Ritron model **RPS-EXPO** 110 VAC to 12 VDC cube power supply. When using an external 12 VDC supply, Alkaline or NiCd batteries can be used as back-up. See page 4.

If there has been no activity for 10 seconds, i.e. either the **ON/PTT** Button has not been pressed or a call has not been received, the unit automatically shuts **OFF**.

Low Battery Alert

The callbox will transmit an Alert Tone at the end of each transmission when the batteries approach end-of-life. This allows sufficient time for you to replace the batteries and assure uninterrupted service.

2013 FCC NARROWBAND MANDATE.....

On January 1, 2013, pursuant to the FCC Narrowband mandate, Ritron will no longer be allowed to manufacture wide band (25 kHz) capable radio equipment that operates in the frequency bands from 150 MHz to 512 MHz. All Ritron RQX Series Callboxes are FCC certified for narrowband operation, so the only change required is the elimination of wideband operation.

To meet the FCC narrowband mandate by Jan 1, 2013, Ritron will initiate the transition process of manufacturing narrowband only compliant radio equipment beginning July 1, 2012. After that date, customer orders will begin to be filled with radios manufactured for FCC narrowband compliance,

with no provisions for wideband operation except where allowed by FCC rule. These radios will be clearly marked as “FCC Narrowband Compliant”. The narrowband manufacturing process will proceed gradually on a model by model basis, with all models narrowband compliant by the January 1, 2013 deadline.

For a complete list of Ritron radios capable of narrowband operation; a Ritron FAQ on the subject, and various links on the FCC website dealing with Narrowbanding go to:

www.ritron.com/narrowband

If you have any questions contact us at 1-800-872-1872

EXPOSURE TO RADIO FREQUENCY ENERGY

These products generate radio frequency (RF) energy when the ON/PTT button on the front of the unit is depressed. These products have been evaluated for compliance with the maximum permissible exposure limits for RF energy at the maximum power rating of the unit when using antennas available from RITRON.

These products are not to be used by the general public in an uncontrolled environment unless compliance with the Uncontrolled / General Population limits for RF exposure can be assured.

Antennas other than those available from RITRON listed below have not been tested for compliance and may or may not meet the exposure limits at the distances given. Higher gain antennas are capable of generating higher fields in the strongest part of their field and would, therefore, require a greater separation from the antenna.

RQX-451: For both the AFB-1545 and RAM-1545 antennas, at the 20 cm (7.9 inches) minimum expected separation distance and greater, the maximum RF exposure is well below the General Population / Uncontrolled limits.

RQX-151: To comply with the General Population / Uncontrolled limits, all persons must be at least 7.9 inches (20 cm) from the AFB-1545 antenna which is supplied by RITRON to be attached directly to the top of the unit. For the RITRON RAM-1545 magnet mount antenna, which can be located away from the unit, all persons must be at least 10.8 inches (28 cm) from the antenna.

To limit exposure to RF energy to levels below the limit, please observe the following:

- Use only the antenna(s) available from RITRON for these models. **DO NOT** operate the radio without an antenna.
- Keep talk times as short and infrequent as possible. **DO NOT** depress the **ON/PTT** button when not actually wishing to transmit. These radios are equipped with an internal timer to limit continuous transmit times.
- When transmitting, make certain that the distance limits for the particular model in use are observed.
- **DO NOT** allow children to operate the radio.

When used as directed, this series of radios is designed to comply with the FCC’s RF exposure limits for “Uncontrolled / General Population”. In addition, they are designed to comply with the following Standards and Guidelines:

- FCC OET Bulletin 65, Edition 97-01, Supplement C, Evaluating Compliance with FCC Guidelines for Human Exposure to Radio Frequency Electromagnetic Fields.
- American National Standards Institute (C95.1-1992), IEEE Standard for Safety Levels with Respect to Human Exposure to Radio Frequency Electromagnetic Fields, 3 kHz to 300 GHz.
- American National Standards Institute (C95.3-1992), IEEE Recommended Practice for the Measurement of Potentially Hazardous Electromagnetic Fields-RF and Microwave.

APPLYING POWER TO THE OUTPOST® CALLBOX

The Callbox may be powered:

- by six (6) D-cell batteries
- through an external +12 VDC source
- or both

Powering the callbox from internal batteries will allow for an installation that does not require wiring to an external source of power. Powering the callbox by an external source will allow the unit to remain **ON**, like an intercom*.

To provide a useful amount of battery life, one of two battery saver options should also be used. See “Power Management Options” on page 5.

* Automatic Turn Off must be **DISABLED** via Field or PC Programming

Using Internal Batteries

Six (6) D-cell batteries may be installed in the internal battery holder for a no trenching, no wires required installation. If internal batteries are used, a LOW battery alert tone will be transmitted when the battery voltage drops below a programmed value. The LOW battery tone notifies personnel that the batteries should be replaced.

! SPECIAL NOTE: It is recommended the UHF model is NOT set to operate in High Power when using **Alkaline** batteries. Due to the nature of alkaline batteries your transmit power output will decrease rapidly as the batteries are depleted.

Using Rechargeable Batteries for Battery Back-up

If rechargeable batteries are used for battery backup the “Charge Jumper” must be placed into the “charge” position as shown in FIG-1.

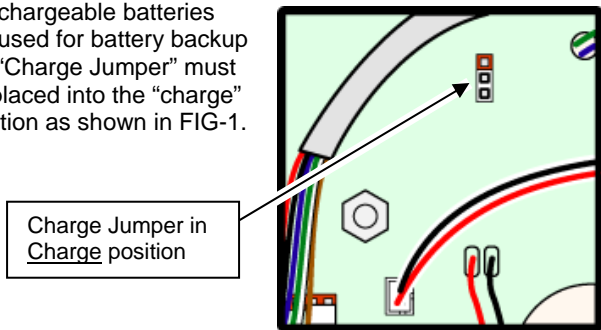

FIG-1: Charge Jumper Shown in Charge Position

!! CAUTION !!

If rechargeable batteries are **NOT** used for battery backup, be sure the “Charge Jumper” is **NOT** in the “charge” position. Charging Alkaline batteries will damage the cells and reduce battery life!

Using External +12 VDC Power with Battery Back-up

Note: An additional hole, strain relief, and conduit will need to be installed into the callbox.

The unit may be powered by an external source of +12 VDC. This source should be filtered, with minimum noise and hum, and capable of supplying at least 1 Ampere.

Order Ritron model **RPS-EXPO** 110 VAC to 12 VDC cube power supply.



Factory Default programming of the callbox is optimized for battery power operation. The External +12 VDC Power Fail Alert option is **NOT ENABLED**.

It is recommended that if an external source of power is used, that the internal batteries be installed as a back-up against loss of power. If this option is chosen, we recommend that the “External +12 VDC Power Fail Alert” feature be **ENABLED** via Field or PC programming.

How the Callbox will Operate:

If External +12 VDC Power Fail Alert Feature is NOT ENABLED:

- Radio always checks for LOW battery or DEAD battery condition when the radio is **ON**.
- If LOW battery is detected, a single Alert Tone will be transmitted at the end of the transmission.
- Radio does **NOT** automatically transmit a LOW battery tone. The callbox must be **ON** and Alert Tone is only sent at the end of a transmission.
- If DEAD battery is detected, the radio ceases all operation. A DEAD battery tone is heard on the callbox speaker and the radio will turn **OFF**.

If External +12 VDC Power Fail Alert Feature is ENABLED:

- Radio always checks for External +12 VDC when the radio is **ON**. If loss of External +12 VDC is detected while the radio is in standby: *a single Alert Tone will be transmitted immediately.*
- If loss of External +12 VDC is detected while the radio is in receive: *a single Alert Tone will be transmitted after the received message is complete.*
- If loss of External +12 VDC is detected while the radio is in transmit: *a single Alert Tone will be transmitted at the end of the transmission.*
- Once loss of External +12 VDC is detected and the Alert Tone is transmitted, the radio will automatically send the Alert Tone once every hour until External +12 VDC is restored or the batteries are exhausted. If radio is set for Automatic Turn-Off (default setting) this hourly alert will **NOT** occur.
- If Dead battery is detected the radio ceases all operation, a DEAD battery tone is heard on the callbox speaker and the radio will turn **OFF**.

APPLYING POWER TO THE OUTPOST® CALLBOX (CONTINUED)

Using External +12 VDC Power without Battery Back-up

The Ritron 1-Series callbox can be programmed for always-on operation by disabling the Automatic Turn-Off option. This is accomplished using the RQX PC Programmer, or through Field Programming. Once Automatic Turn-Off is disabled, the user simply turns on the RQX by pressing the front panel PTT button and it will remain on as long as power is applied. If power to the callbox is lost, the user must press the front panel PTT to restart the radio. For externally powered callboxes, battery backup is one method of keeping the radio on if the primary external power is lost.

For users that do not want to rely on battery backup, and do not want to “restart” the callbox after a power loss, the callbox can be modified to automatically restart after a power loss.

For details or questions about this modification contact Ritron at 1-800-872-1872 and reference Ritron publication 14670028, RQX 1-Series, 6-Series and 7-Series Callbox Modification for Always On Operation.

Important considerations before applying this modification:

- The Automatic Turn-Off option must be disabled.
- When Automatic Turn-Off is disabled the unit will consume the largest amount of current, but is always ready to instantly receive messages. This mode should only be considered if an external source of +12 VDC is available.
- The callbox receiver will always be on. All radio communication on the programmed frequency and tone will be heard over the RQX callbox.

POWER MANAGEMENT OPTIONS

There are three power management options available to the 1 Series OUTPOST® Callbox:

Automatic Turn-Off (Field or PC Programmable)

In this mode, the callbox will automatically turn itself off after a programmed period of no activity (**no transmissions made and no calls received**) has elapsed. Once the unit has turned itself off, it can only be turned back on by depressing the **ON/PTT** Button. The programmed period of no activity necessary before the unit turns itself off is called the **RQX Reset Time**. RQX Reset Time and Automatic Turn-Off can both be Field programmed, or PC programmed by the factory or your Ritron dealer via the Ritron RQX Series PC Programmer. Automatic Turn-Off mode is the factory default mode for power management with an RQX Reset Time of 10 seconds.

Battery Saver (PC Programmable Only)

This mode is similar to the Automatic Turn-Off mode except that the unit does **NOT** turn itself off after the RQX Rest Time has elapsed. Instead it reverts to a mode where the unit goes to sleep and periodically wakes up to test for receive activity on the channel. The Sleep Period (called Battery Saver Sleep Time) can be set using the Ritron RQX Series PC Programmer to between 0.5 and 8 seconds. Longer sleep times result in better battery life, but increase the chances that activity on the channel may be missed. The unit will come out of this mode when activity is detected during the wake-up period or if the **ON/PTT** button is pressed. The Automatic Turn-Off and Battery Saver modes cannot be used together.

Neither “Automatic Turn-Off” nor “Battery Saver” Used (Field or PC Programmable)

If neither Automatic Turn-Off nor Battery Saver are used the unit will consume the largest amount of current, but is always ready to instantly receive messages. This mode should only be considered if an external source of +12 VDC is available (see “Using External +12 VDC Power with Battery Back-up” on page 4).

CALLBOX CONTROLS AND CONNECTORS

Antenna Connector

The antenna radiates radio signals. Before using the 1 Series OUTPOST® Callbox, make sure the antenna is securely fastened into the 50Ω BNC antenna connector. If the OUTPOST® is to be used outdoors, see page 9 for instructions on properly sealing the antenna connector.

RF Mating Connectors

An internal cable from the antenna connector is terminated into an SMB style connector for connection to the radio circuit board.

Captive Plastic Case Screws

A captive plastic case screw is located in each corner of the case front. These four (4) screws are used to secure the case front containing the radio, to the case back that contains the batteries.

Charge Jumper

The charge jumper can be set to trickle charge re-chargeable backup batteries (see "Using Re-chargeable Batteries for Battery Back-up" on page 4).

12 VDC Input Connector

The 6-pin, polarized connector allows connection of an external +12 VDC input.

Speaker Connector

The internal speaker is connected to the radio printed circuit board with a polarized connector.

On/PTT Connector

The ON/PTT switch is connected to the radio printed circuit board with a polarized connector.

Pre-Drilled Mounting Holes

Mounting holes located in the 4 corners of the case back are pre-drilled for mounting to a plate, wall or post. Once mounted, the case front is secured to the case back through these same threaded holes.

RJ-11 Program Cable Connector

An RJ-11 style connector is used to connect the cable from the PC programmer to the radio.

Program Button

A small, momentary pushbutton is used for field programming the OUTPOST® Callbox.

Program Display

A single digit LED display is used during field programming of the radio.

Battery Holder

The battery holder inside the case back is used for the installation of 6 D-cell Alkaline or rechargeable batteries. Refer to the diagram below, or the labels beneath the cells, for correct installation of the batteries.

Battery Mating Connectors

Polarized, 2-pin mating connectors are used to connect the batteries to the radio circuit board.

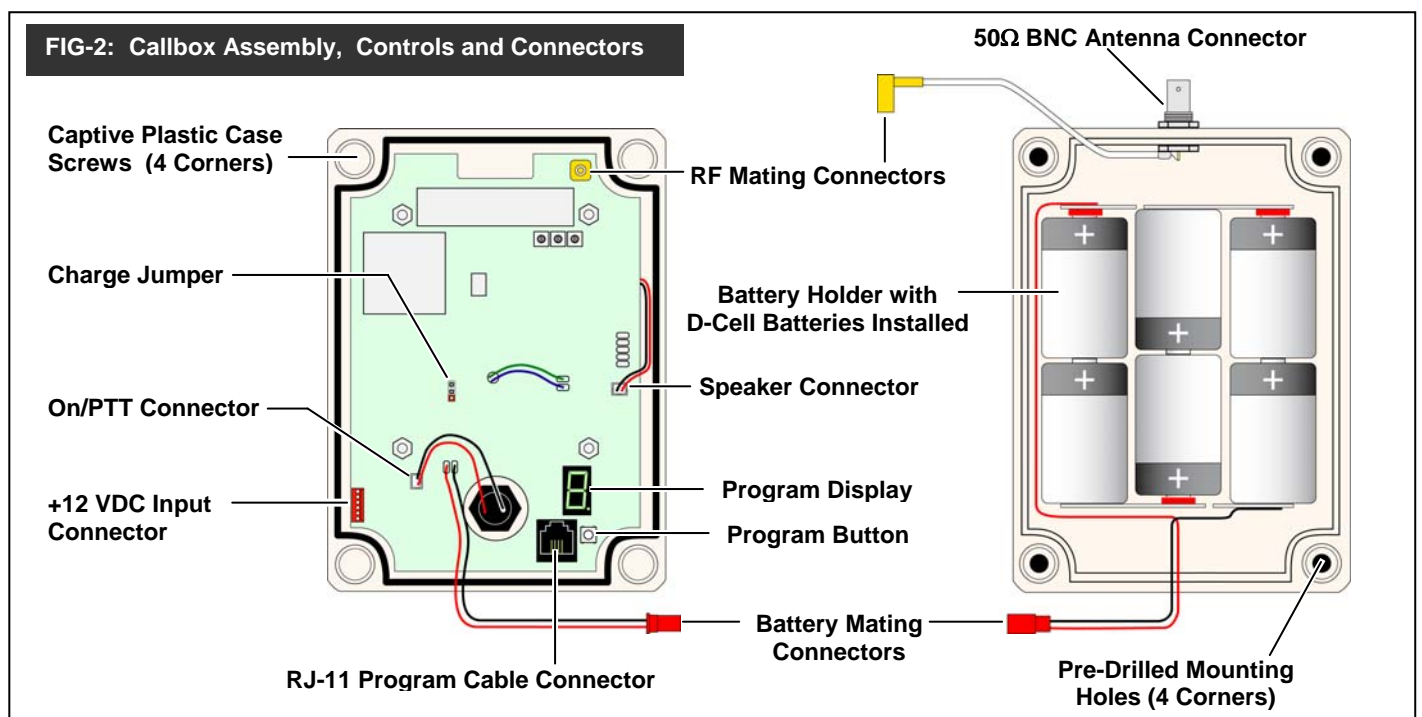
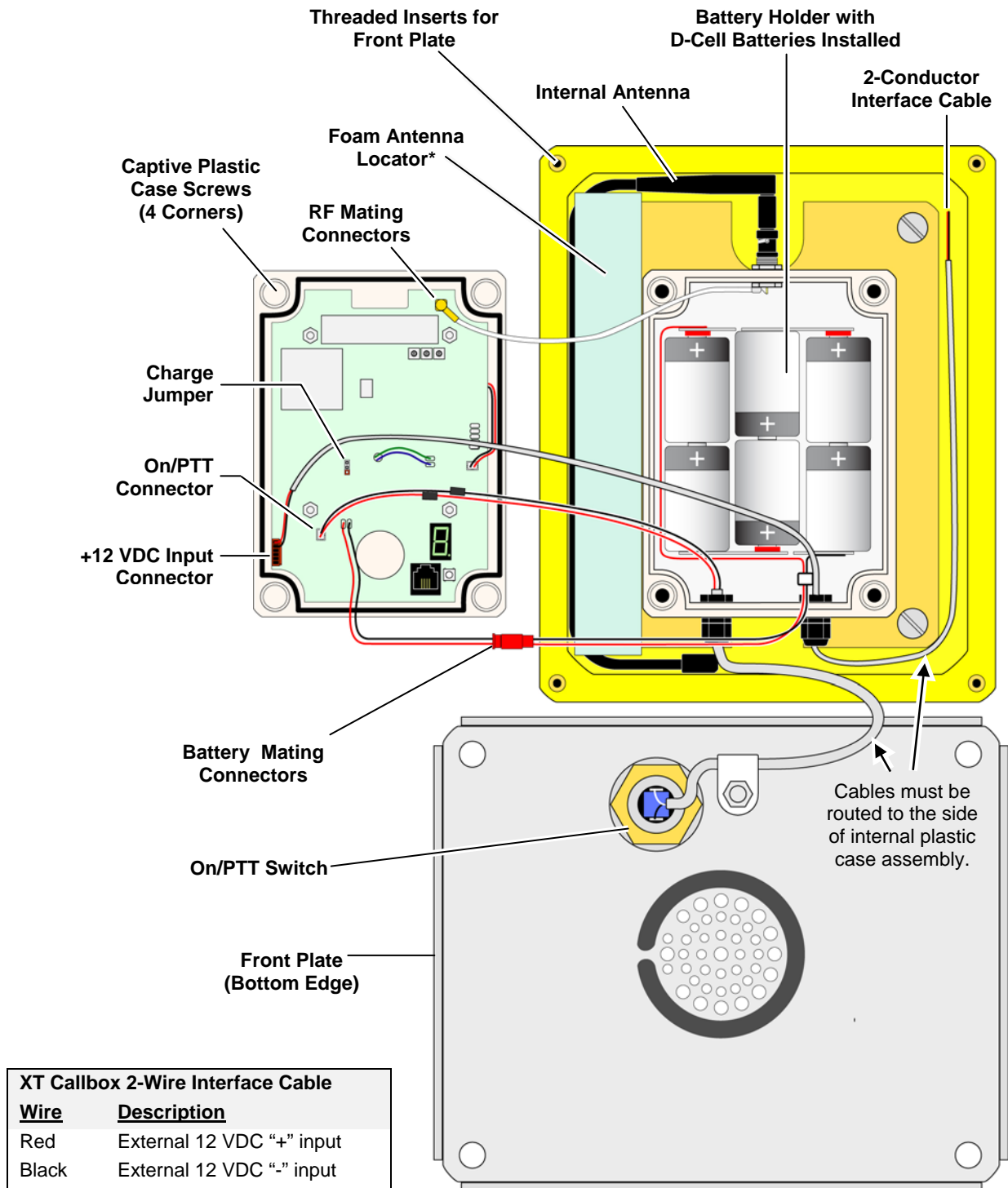

FIG: 3 XT CALLBOX ASSEMBLY



- **Do not remove the foam Antenna Locator.** The foam Antenna Locator is used to position the antenna for optimum performance. The antenna should be routed in the slot on Antenna Locator, along the inside of the XT case as shown. The tip of the antenna should not come in contact with any of the connecting cables.

BASIC OUTPOST® INSTALLATION INSTRUCTIONS

The Basic model can be mounted to virtually any surface with four (4) #6 panhead screws. Choose a type of screw thread and screw length which will hold firmly in the surface to which the unit will be mounted.

MOUNTING the Basic OUTPOST®: (Refer to FIG-2)

- Loosen the four (4) captive screws in the front corners of the case and separate the case front from the case back. These screws are captive to the housing; to prevent damaging them, **DO NOT** remove the screws from the housing.
- Install 6 D-cell Alkaline or rechargeable batteries into the battery holder. Refer to FIG-2, or the labels beneath the cells, for correct installation of the batteries.
- If required, program the radio. Refer to the programming section of this manual for details.
- Disconnect the RF mating connectors and the battery mating connectors. Set the case front containing the radio circuit board aside.
- Insert a #6 panhead screw into each of the four (4) corner holes in the Basic model case back. Position the case back in the chosen installation location and secure it in place with the four screws.
- Re-connect the RF mating connectors and the battery mating connectors between the case front and case back.
- Fasten the case front to the case back with the four (4) captive screws. **DO NOT** over-tighten the plastic screws to prevent damage.
- Insert, rotate and lock the antenna onto the antenna connector. Orient the antenna vertically.
- If the Basic model is to be used outdoors, it is imperative that the antenna connector be sealed with sealing tape after the antenna has been installed. Use Grainger #2A-459, Radio Shack #278-1647, or equivalent seal tape. Refer to "Sealing the Antenna" instructions in this manual.
- To install the message placard, align the center of the hole over the **ON/PTT** Button, and the mushroom-head fastener strips on the back of the placard with the strips on the front of the Basic model case. Press firmly to interlock the strips, snapping the panel into position.



CAUTION Do not drill or penetrate the OUTPOST® case with any additional holes. Use only the pre-drilled mounting holes.

COVERAGE

Depending on the unit location and installation, the OUTPOST® set for 1 Watt can cover up to 1 mile line of sight. To increase range, use an external antenna that is mounted higher. Contact RITRON for a RAM-1545 Magnet Mounted Antenna. Refer to Special Note on page 4.

XI OUTPOST® INSTALLATION INSTRUCTIONS

The XT model can be mounted to virtually any surface with four (4) ¼" diameter fasteners, not included. Choose a type of screw thread and screw length which will hold firmly in the surface to which the unit will be mounted.

MOUNTING the XT OUTPOST®: (Refer to FIG-3 and FIG-4)

- Place the XT callbox on a flat work surface. Remove the front faceplate from the callbox. The faceplate is secured to the case with 4 vandal-resistant buttonhead, Torx screws. Use the T-25 Torx bit included with the radio to remove these screws.
- Remove the "Mounting Tabs" kit secured to the inside of the XT callbox case.
- Loosen the (4) captive screws in the front corners of the internal XT callbox case and separate the case front from the case back. The screws are captive to the housing; to prevent damaging them, **DO NOT** remove the screws from the housing.
- Install 6 D-cell Alkaline or rechargeable batteries into the battery holder. Refer to FIG-3, or the labels beneath the cells, for correct installation of the batteries.
- If required, program the radio. Refer to the programming section of this manual for details.
- Fasten the internal case front to the case back with the four (4) captive screws. To prevent damage, do not over-tighten the plastic screws.
- Re-fasten the front faceplate to the radio with the 4 buttonhead Torx screws.
- Install the four (4) mounting tabs to the back of the XT callbox case as shown in FIG-4 with the #10-32 bolts provided. The mounting tabs can be installed vertically, as shown, or horizontally.
- Position the XT callbox in the chosen installation location and secure it in place with four (4) screws through the mounting tabs.

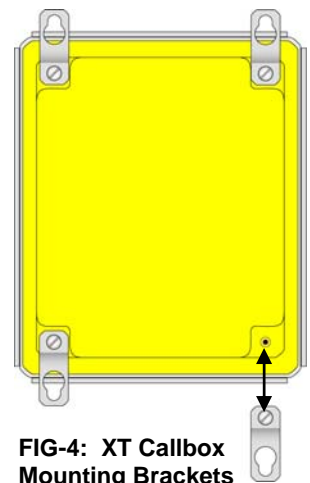

FIG-4: XT Callbox Mounting Brackets

OPTIONAL XT OUTPOST® MOUNTING BRACKET INSTALLATION INSTRUCTIONS

The optional XT Mounting Bracket (order part # XTMK) can be attached to the callbox for special applications with two (2) ¼" diameter fasteners, NOT included. Choose a type of screw thread and screw length which will fasten the callbox securely to the mounting surface.

MOUNTING the OPTIONAL XT OUTPOST® BRACKET: Refer to FIG-5 :

1. Using the XTMK bracket as a template, mark the two (2) holes #2 (see FIG-5) on the mounting surface you intend to fasten the bracket.
2. Find a flat work surface and using the included four (4) button head tamper resistant fasteners, attach the XTMK bracket to the existing holes on the back of the XT callbox (holes #1), as shown in FIG-5.
3. Secure the XTMK bracket to the mounting surface using holes #2 and two (2) ¼" fasteners (NOT included), as shown in FIG-5. Make sure mounting surface and fasteners are capable of supporting the total weight of the XT callbox.

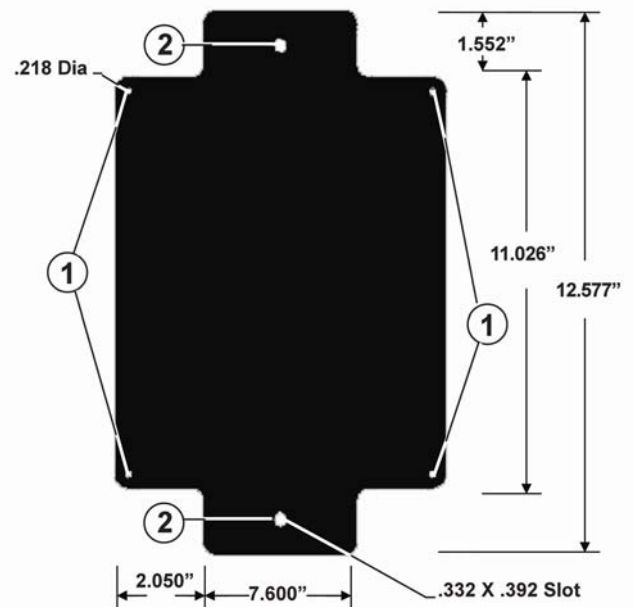

**FIG-5: Optional XTMK Mounting Bracket
XT Callbox**

HOW TO SEAL THE ANTENNA

If a basic OUTPOST® Callbox is to be used outdoors it is imperative that the entire antenna connection be sealed with seal tape to provide proper operation and prevent voiding warranty.

Seal tape can be purchased at most Industrial Supply Stores, Hardware and Home Center Stores, or Electronic Supply Stores.

Regardless of the antenna used, it is always best to weatherproof the antenna connection using seal tape.

NOTICE

Failure to follow these instructions will cause damage to the product, prevent proper sealing of the enclosure and will void the Manufacturers Warranty.

Applying Seal Tape:

1. Attach the antenna to the 50Ω BNC connector on the OUTPOST® Callbox enclosure.
2. Begin wrapping seal tape at the base of the antenna connector such that it is sealed to the enclosure top.
3. Overlap the seal tape as you tightly wrap upward around the connector and antenna. Continue to overlap seal tape around the connector base, past the articulated portion of the antenna and several inches up the thin, shiny section of the antenna.

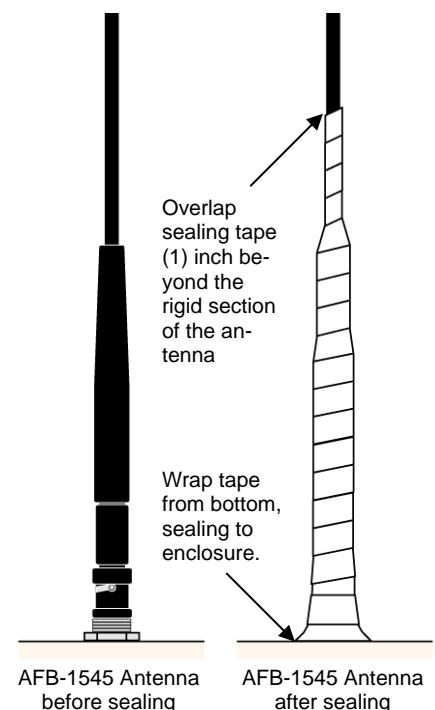

HOW TO READOUT CURRENT RADIO FREQUENCY & TONE CODES

- Loosen the (4) captive screws in the front corners of the case. These screws are captive to the housing; to prevent damaging them, **DO NOT** remove the screws from the housing.
- Separate the case front from the case back, leaving the batteries connected to the radio. Make sure the unit has batteries installed. **NOTE:** The voltage of the batteries must be greater than 6 VDC to program properly.
- Press and **RELEASE** the **ON/PTT** button on the front of the Callbox to turn the radio on.
- Press and **RELEASE** the Program button (See FIG-2 on page 6 for location). The radio will immediately begin to display a series of four digits; with each digit separated by a hyphen.
- Write down the four digits. The first two digits indicate the frequency code and the last two digits the tone code; see [Table 1](#) and [Table 2](#) on pages 12 and 13. In this example an RQX-451 is programmed to operate on the "Brown Dot" frequency of 464.500 MHz (Frequency code "04") with 100.0 Hz tone (Tone code "12").



FREQUENCY CODE



TONE CODE

- If a 5th digit is displayed, the channel has been programmed for DQC and the last three digits indicate the DQC code; see [Table 3](#) on page 13. In this example an RQX-451 was programmed to operate on the "Brown Dot" frequency of 464.500 MHz (Frequency code "04") with a DQC code of "723".



FREQUENCY CODE



DQC CODE

- If the channel is PC programmed with any frequency or tone not listed in [Table 1](#), [Table 2](#) or [Table 3](#) on pages 11 and 12, the radio will sound the **ERROR TONE** on contents read out and display an "E". The PC programmer will be required to readout the radios frequency and tone programming.



- Normal radio operation resumes after the programming information has been displayed.

HOW TO FIELD PROGRAM FREQUENCY & TONE CODES

To match other radios, the owner can select Frequency, Tone and DQC Codes from [Table 1](#), [Table 2](#) and [Table 3](#) on pages 11 and 12. In our example, we will program an RQX-451 to operate on the "Brown Dot" frequency of 464.500 MHz with 100.0 Hz tone.

NOTE: If the callbox has been PC programmed to a non-table frequencies it cannot be changed via field programming. You can, however, change the QC or DQC Tone Code via field programming by using the "No Change" Frequency Code "99" followed by the desired QC or DQC Tone Code.

04 1. Refer to [Table 1](#) on page 12 to determine the two-digit frequency code and write it down.

12 2. Refer to [Table 2](#) on page 13 to determine the two-digit tone code for 100.0 Hz and write it down.

3. Loosen the (4) captive screws in the front corners of the case. These screws are captive to the housing; to prevent damaging them, **DO NOT** remove the screws from the housing.

4. Separate the case front from the case back, leaving the batteries connected to the radio. Make sure the unit has batteries installed.
NOTE: The voltage of the batteries must be greater than 6 VDC to program properly.

5. Press and release the **ON/PTT** button on the front of the unit to turn the radio on.



6. Press and **HOLD** the Program Button (See FIG-2 on page 6 for location). A "P" will appear on the program display as you enter program mode and the radio will beep rapidly.



7. Release the program button after the beeping has stopped. The radio will emit a triple beep indicating that the radio is in program mode and a hyphen will appear on the program display.

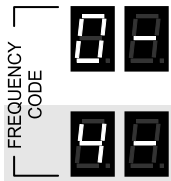

8. Enter the 1st digit of the frequency code by clicking the Program button until the program display shows the desired number. Pause—the radio will sound a low tone and show a hyphen across the center of the display to indicate that it is ready to accept the next digit.

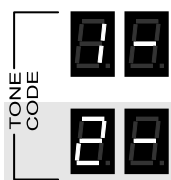

9. Enter the 2nd digit of the frequency code by clicking the Program button until the program display shows the desired number. Pause—the radio sounds a low tone and will show a hyphen across the center of the display to indicate that it is ready to accept the next digit.

10. Enter the 1st digit of the tone code (or 1st digit of the DQC code) by clicking the Program button until the program display shows the desired number. Pause—the radio sounds a low tone and will show a hyphen across the center of the display to indicate that it is ready to accept the next digit.

11. Enter the 2nd digit of the tone code (or 2nd digit of the DQC code) by clicking the Program button until the program display shows the desired number. Pause—the radio sounds a low tone and will show a hyphen across the center of the display to indicate that it is ready to accept the next digit.

12. **FOR DQC CODES ONLY** – Enter the 3rd digit of the DQC code by clicking the Program button until the program display shows the desired number. Pause—the radio sounds a low tone and will show a hyphen across the center of the display to indicate that it is ready to accept the next digit.

13. Press and release the **ON/PTT** button to save your programming. A triple beep will sound to indicate that programming was successful and a hyphen will appear on the program display. The radio is now ready for another program entry.



NOTE: An error tone will sound if you attempt to save an incorrect code, an "E" will appear on the display. Check the digits you are attempting to enter, then re-enter.

14. Once you have made your final program entry, press the **ON/PTT** button a final time to turn the radio off. Turn the radio back on for normal operation.

TABLE 1: PROGRAMMABLE FREQUENCY CODES.....

UHF Business Band				UHF Business Band				VHF Business Band			
Code	Frequency	Color Dot	BW	Code	Frequency	Color Dot	BW	Code	Frequency	Color Dot	BW
01	467.7625	J	12.5 †	40	461.2875		12.5	03	151.625	Red Dot	12.5 †
02	467.8125	K	12.5 †	41	461.3125		12.5	04	151.955	Purple Dot	12.5 †
03	464.5500	Yellow Dot	12.5 †	42	461.3375		12.5	05	151.925		12.5 †
04	464.5000	Brown Dot	12.5 †	43	461.3625		12.5	06	154.540		12.5 †
05	467.8500	Silver Star	12.5 †	44	462.7625		12.5	07	154.515		12.5 †
06	467.8750	Gold Star	12.5 †	45	462.7875		12.5	08	154.655		12.5 †
07	467.9000	Red Star	12.5 †	46	462.8125		12.5	09	151.685		12.5 †
08	467.9250	Blue Star	12.5 †	47	462.8375		12.5	10	151.715		12.5 †
09	469.2625		12.5 †	48	462.8625		12.5	11	151.775		12.5 †
10	462.5750	White Dot	12.5 †	49	462.8875		12.5	12	151.805		12.5 †
11	462.6250	Black Dot	12.5 †	50	462.9125		12.5	13	151.835		12.5 †
12	462.6750	Orange Dot	12.5 †	51	464.4875		12.5	14	151.895		12.5 †
13	464.3250		12.5 †	52	464.5125		12.5	15	154.490		12.5 †
14	464.8250		12.5 †	53	464.5375		12.5	16	151.655		12.5 †
15	469.5000		12.5 †	54	464.5625		12.5	17	151.745		12.5 †
16	469.5500		12.5 †	55	466.0375		12.5	18	151.865		12.5 †
17	463.2625		12.5 †	56	466.0625		12.5	24	151.700		12.5
18	464.9125		12.5 †	57	466.0875		12.5	25	151.760		12.5
19	464.6000		12.5 †	58	466.1125		12.5	26	152.700		12.5 †
20	464.7000		12.5 †	59	466.1375		12.5	99	No change		---
21	462.7250		12.5 †	60	466.1625		12.5				
22	464.5000		12.5	61	466.1875		12.5				
23	464.5500		12.5	62	466.2125		12.5				
24	467.7625		12.5	63	466.2375		12.5				
25	467.8125		12.5	64	466.2625		12.5				
26	467.8500		12.5	65	466.2875		12.5				
27	467.8750		12.5	66	466.3125		12.5				
28	467.9000		12.5	67	466.3375		12.5				
29	467.9250		12.5	68	466.3625		12.5				
30	461.0375		12.5	69	467.7875		12.5				
31	461.0625		12.5	70	467.8375		12.5				
32	461.0875		12.5	71	467.8625		12.5				
33	461.1125		12.5	72	467.8875		12.5				
34	461.1375		12.5	73	467.9125		12.5				
35	461.1625		12.5	74	469.4875		12.5				
36	461.1875		12.5	75	469.5125		12.5				
37	461.2125		12.5	76	469.5375		12.5				
38	461.2375		12.5	77	469.5625		12.5				
39	461.2625		12.5	99	No change		---				

VHF MURS**			
Code	Frequency	Color Dot	BW
01	154.600	Green Dot	25.0
02	154.570	Blue Dot	25.0
19	151.820	MURS	12.5
20	151.880	MURS	12.5
21	151.940	MURS	12.5
22	154.600	MURS	12.5
23	154.570	MURS	12.5

Notes			
** MURS frequencies do not require an FCC license. All other frequencies require an FCC license.			
† Frequency code was 25 KHz bandwidth prior to the 2013 FCC Narrowband Mandate.			
• BW is the bandwidth in kHz.			
• 12.5 kHz indicates a narrow band channel, 25 kHz indicates a wide band channel.			

Note: If the callbox has been PC programmed to a non-table frequencies it cannot be changed via field programming. You can, however, change the QC or DQC Tone Code via field programming by using the "No Change" Frequency Code "99" followed by the desired QC or DQC Tone Code.

CANADIAN FREQUENCY CODES.....

Canada Models UHF Business Band				Canada Models VHF Business Band				British Columbia Models VHF Business Band			
Code	Frequency	Color Dot	BW	Code	Frequency	Color Dot	BW	Code	Frequency	Color Dot	BW
01	458.6625		25	01	151.055		25	01	154.100		25
02	469.2625		25	02	151.115		25	02	158.940		25

TABLE 2: INTERFERENCE ELIMINATOR PROGRAMMABLE QC TONE CODES

Code	Frequency	Code	Frequency	Code	Frequency	Code	Frequency
01	67.0	14	107.2	27	167.9	40	159.8
02	71.9	15	110.9	28	173.8	41	165.5
03	74.4	16	114.8	29	179.9	42	171.3
04	77.0	17	118.8	30	186.2	43	177.3
05	79.7	18	123.0	31	192.8	44	No Tone
06	82.5	19	127.3	32	203.5	45	183.5
07	85.4	20	131.8	33	210.7	46	189.9
08	88.5	21	136.5	34	218.1	47	196.6
09	91.5	22	141.3	35	225.7	48	199.5
10	94.8	23	146.2	36	233.6	49	206.5
11	97.4	24	151.4	37	241.8	50	229.1
12	100.0	25	156.7	38	250.3	51	254.1
13	103.5	26	162.2	39	69.4	00	No Tone







TABLE 3: DIGITAL INTERFERENCE ELIMINATOR PROGRAMMABLE DQC TONE CODES

Code	Code	Code	Code	Code	Code	Code	Code
023	072	152	244	311	412	466	631
025	073	155	245	315	413	503	632
026	074	156	246	325	423	506	645
031	114	162	251	331	431	516	654
032	115	165	252	332	432	523	664
036	116	172	255	343	445	532	703
043	122	174	261	346	446	546	712
047	125	205	263	351	452	565	723
051	131	212	265	356	454	606	731
053	132	223	266	364	455	662	732
054	134	225	271	365	462	612	734
065	143	226	274	371	464	624	743
071	145	243	306	411	465	627	754

HOW TO FIELD PROGRAM FEATURE CODES.....

The 1 Series OUTPOST® Callbox can be field programmed for a number of simple and advanced features. Refer to **Table 4** below for the simple, single digit codes available for field programming. Refer to **Table 5** for the advanced three digit codes available for field programming. In our example we will program an RQX-451 for an RQX Reset Time of 30 seconds.

804

1. Refer to [Table 5](#) to determine the three-digit feature code and write it down.
2. Loosen the (4) captive screws in the front corners of the case. These screws are captive to the housing; to prevent damaging them, **DO NOT** remove the screws from the housing.
3. Separate the case front from the case back, leaving the batteries connected to the radio. Make sure the unit has batteries installed.
NOTE: The voltage of the batteries must be greater than 6 VDC to program properly.
4. Press and release the **ON/PTT** button on the front of the unit to turn the radio on.
5. Press and **HOLD** the Program Button (See FIG-2 on page 6 for location). A "P" will appear on the program display as you enter program mode and the radio will beep rapidly.
 
6. Release the program button after the beeping has stopped. The radio will emit a triple beep indicating that the radio is in program mode and a hyphen will appear on the program display.
7. Enter the 1st digit of the feature code by clicking the Program button until the program display shows the desired number. Pause—the radio will sound a low tone and show a hyphen across the center of the display to indicate that it is ready to accept the next digit.
NOTE: If entering a simple, single digit code skip to step 10.
 
8. Enter the 2nd digit of the feature code by clicking the Program button until the program display shows the desired number. Pause—the radio sounds a low tone and will show a hyphen across the center of the display to indicate that it is ready to accept the next digit.
 
9. Enter the 3rd digit of the feature code by clicking the Program button until the program display shows the desired number. Pause—the radio sounds a low tone and will show a hyphen across the center of the display to indicate that it is ready to accept the next digit.
 
10. Press and release the **ON/PTT** button to save your programming. A triple beep will sound to indicate that programming was successful and a hyphen will appear on the program display. The radio is now ready for another program entry.
 
11. Once you have made your final program entry, press the **ON/PTT** button a final time to turn the radio off. Turn the radio back on for normal operation.
 

NOTE: An error tone will sound if you attempt to save an incorrect code, an "E" will appear on the display. Check the digits you are attempting to enter, then re-enter.

TABLE 4: SINGLE DIGIT RADIO FEATURE CODES

Code	Feature	Default	Description
1			
2			
3	Volume Level – Medium	√	Sets Volume level to 50%
4	Volume Level – High		Sets Volume level to 100%
5			
6			
7	Transmit Low Pwr (1 W)	√	
8	Transmit High Pwr (2 W)		UHF Model Only: Refer to Special Notice on page 4 regarding Alkaline Battery usage.
9	Call Tone ON	√	
0	Call Tone OFF		When PTT button is initially pressed a Call Tone will be transmitted.

√ The Callbox is set from the factory with these options **enabled**.

TABLE 5: ADVANCED FEATURE CODES

Code	Feature	Default	Description
RQX Reset Time			
801	5 seconds		RQX Reset Time is the length of time the RQX Callbox can remain inactive (not receiving or transmitting) before it automatically shuts off.
802	10 seconds	√	
803	20 seconds		
804	30 seconds		
805	45 seconds		
806	1 minute		
807	2 minutes		
808	3 minutes		
809	4 minutes		
Special Features			
821	Reset to Factory Defaults		Resets Callbox to Factory default programming.
822	Display Radio Revision		Callbox will display a sequence of 6 digits to identify operating code revision. This is helpful when troubleshooting the radio.
823	Enable External +V		Enables the External +V “Loss of power” notification feature.
824	Disable External +V	√	Disables the External +V “Loss of power” notification and reverts back to “Low Battery” notification.
825	Enable Auto Turn-Off	√	Callbox will automatically turn off when it has not been used (transmit or receive) for a period of time longer than the RQX Reset Time.
826	Disable Auto Turn-Off		Callbox will remain on at all times. This mode of operation is not recommended for battery-powered applications.
827	Enable Busy Channel TX Inhibit		Callbox cannot transmit when there is a received signal. A “busy signal” will be heard on the Callbox speaker when the PTT is pressed and a received signal is present.
828	Disable Busy Channel TX Inhibit	√	Callbox will transmit whenever the PTT is pressed, regardless of any received signal.
829	Mic Gain High		Places the microphone into high gain operation where quiet and distant voices will be heard. This mode of operation will increase background noise transmitted by the Callbox.
820	Mic Gain Normal	√	Places the microphone into normal gain operation for the majority of applications where the user is talking directly into the Callbox. This mode of operation will decrease background noise transmitted by the Callbox.
Receive Volume Level			
875	10%		Sets the speaker volume level of received signals.
876	25%		
877	50% *	√	
878	75%		
879	100% *		

√ The Callbox is set from the factory with these options **enabled**.
 * Setting is also available with Single-Digit Radio Feature Code programming.

PROGRAMMABLE OUTPOST® CALLBOX FEATURES

The OUTPOST® Callbox has a variety of programmable features that determine how your callbox operates. Some of these features can be Field Programmed (FP) by you **without** using special tools, while other features can only be Programmed (PC) with a PC and RQX Series PC Programmer version 10.1.0 or higher. Contact your Ritron dealer or the factory for details.

Glossary of Terms

Intercom Mode – The Automatic Turn-Off feature has been disabled and the Callbox is able to receive calls at any time.

Sleep – If Automatic Turn-Off is **DISABLED** and Battery Saver is **ENABLED** the Callbox will go into a low current Sleep Time when it is not being used, waking up periodically to check for a received message. Pressing the **ON/PTT** button will wake-up the radio immediately.

Wake-Up – When Battery Saver is **ENABLED** and the Callbox has entered the low current Sleep state, the radio will wake-up periodically to check for a received message. The Sleep Time is set by the Battery Saver Sleep Time.

No Activity Time – A continuous period of time where the Callbox is not sending or receiving a call.

Programmable Features Key:

FP for Field Programmable Feature – no software required
PC for PC Programmable Feature with Software

Field Programming Enable (PC)

This option is **ENABLED** as the Factory Default setting. This permits all Field Programmable features (FP) to be field programmed by you. If **DISABLED**, the features can only be programmed using special Ritron PC Programming software.

Send Call Tone (PC or FP)

The Factory Default setting has the Call Tone feature **ON** (refer to “How to Field Program Feature Codes on page 14). The callbox can be programmed to transmit a Call Tone if the Reset Time has expired and the **ON/PTT** button is pressed. This will alert system users that the call is originating from the callbox.

Narrow or Wide Band Operation..... (PC)

A number of table frequencies, which are Field Programmable, offer you a choice between narrow (12.5 kHz) or wide (25 kHz) band operation. See “TABLE 1: PROGRAMMABLE FREQUENCY CODES” on page 12. The callbox automatically makes the narrow or wide band adjustment depending on the frequency code selected.

The callbox can be PC programmed with Ritron RQX software to operate either narrow or wide band on any custom frequency within the specified band.

Refer to the section [2013 FCC Narrowband Mandate](#) to see if your radio is capable of wideband transmit operation.

Speaker Volume (PC or FP)

The Factory Default setting is medium volume. Field programming allows you to select from 5 different Volume settings. PC Programming allows any volume level between 2 – 100%. A lower speaker volume reduces audio distortion and provides a more natural sound. For best performance, do not set the volume any higher than is necessary for your application.

High/Low Power (PC or FP)

The UHF callbox can be set to transmit at high (2-Watt) or low (1-Watt) power. Low power is recommended in battery powered installations.



Refer to [Special Note](#) on page 4 regarding **Alkaline** batteries.

Busy Channel TX Inhibit(PC or FP)

With this feature enabled the Callbox cannot transmit when there is a received signal. A “busy signal” will be heard on the Callbox speaker when the PTT is pressed and a received signal is present. Busy Channel TX Inhibit is disabled from the factory.

Transmit Beep Enable..... (PC)

This feature is turned on from the factory to provide a short beep in the Callbox speaker any time the **ON/PTT** button is pressed. This assures the Callbox user that the radio has turned on and is ready to transmit their message. With this feature disabled the Callbox will only beep when the radio is first turned on.

RX Courtesy Beep Enable (PC)

In high noise environments it is sometimes difficult to determine when a received message has ended. With the RX Courtesy Beep enabled the Callbox will sound a short beep on the speaker at the end of each received transmission.

RQX Reset Time(PC or FP)

Set from the factory for 10 seconds, the RQX Reset Time can be Field Programmed to 9 different times ranging from 5 seconds to 4 minutes, and PC programmed for 5-255 seconds. A shorter RQX Reset Time will result in increased battery life. In standard Automatic Turn-Off operation a longer RQX Reset Time will allow more time for a response before the Callbox turns off.

RQX Reset Time defines the Inactivity Time allowed before the Callbox:

- Turns Off if Automatic Turn-Off is ENABLED.
- Enters Battery Saver mode if Battery Saver is ENABLED.

PROGRAMMABLE OUTPOST® CALLBOX FEATURES (CONTINUED)

Automatic Turn-Off (PC or FP)

This feature is **ENABLED** as the Factory Default setting. The callbox will turn **OFF** when the RQX Reset Time has expired. The Reset Time is a pre-programmed amount of time of “no activity” (no calls transmitted, no calls received) before the callbox turns **OFF** in order to conserve battery life. The callbox can be turned back **ON** when the **ON/PTT** button is pressed. This is the recommended mode of operation for all battery only powered applications.

If Automatic Turn-OFF is **NOT** selected the callbox does **NOT** completely turn **OFF**, but remains in the Intercom mode, allowing the callbox to receive calls at any time.

Operating the callbox with Automatic Turn-OFF **DISABLED** significantly increases battery drain, and is therefore **NOT** recommended for battery only powered applications. Battery life can be increased using the Battery Saver Enable feature detailed in this section.

Battery Saver Enable (PC)

When the OUTPOST® Callbox is programmed to operate with Automatic Turn-Off disabled, Battery Saver can increase battery life in both internal and external battery powered applications.

With Battery Saver Enable, the callbox will periodically Wake-Up and listen for a received signal before returning to a low current Sleep state. The time between Wake-Up states can be PC programmed between 0.5 - 8 seconds with the Battery Saver Sleep Time setting. A longer time between Wake-Up states will result in increased battery life.

The callbox immediately leaves Battery Saver mode any time the **ON/PTT** Button is pressed or a signal is received, and will not return to Battery Saver until the period of no activity exceeds the RQX Reset Time.

External +12 VDC Power Fail Alert Tone(PC or FP)

By selecting the +12 VDC Power Fail Alert Tone feature the callbox will look for a loss of the +12 VDC power source. The callbox will immediately transmit an Alert Tone to notify personnel that the +12 VDC source has been lost and is now operating on battery back-up. The callbox will transmit an Alert Tone once every hour until the +12 VDC power source is restored or until the back-up batteries are exhausted. Even if this feature is **NOT** selected, it will always revert to Back-up Battery power, see page 4 for details.

DTMF or Selcall ANI(PC)

The RQX can be programmed to send a 1-9 digit DTMF or 3-7 digit Selcall ANI code at the beginning of each transmission for radio identification.

Microphone Gain(PC or FP)

The Microphone can be placed in HIGH or NORMAL gain mode. With the microphone in high gain mode quiet and distant voices will be heard. This mode of operation will increase background noise transmitted by the Callbox.

The Microphone gain is set to NORMAL mode by default. Leave the microphone in normal gain mode for the majority of applications where the user is talking directly into the Callbox. This mode of operation will decrease background noise transmitted by the Callbox.

TX Time Out Time(PC)

Set from the factory for 60 seconds, the TX Time Out Time can be programmed for 1-255 seconds. This sets the length of time the Callbox can transmit continuously. If the **ON/PTT** button is held down longer then the TX Time Out Time will allow, the radio will stop transmitting and a “Busy Signal” will be heard in the speaker until the button is released.

INTERCOM (ALWAYS ON) PROGRAMMING

The OUTPOST® can be PC programmed by the factory or by your Ritron dealer to operate as a two-way intercom. When operating as an intercom the Automatic Turn-Off must be **DISABLED** so that the radio will remain **ON** in a “intercom” mode. The callbox can receive a call from another radio at any time. The higher current requirements of Intercom operation make it undesirable in battery powered only installations. It is recommended that you power the callbox using +12 VDC capability. See page 4.

Required Radio Settings:

Automatic Turn-Off (PC or FP)

This feature must be **DISABLED** for the callbox to remain **ON** at all times.

Other Programmable Features to Consider:

Battery Saver (PC)

Battery Saver can be used to increase battery life in battery powered applications. With Battery Saver enabled, the callbox will periodically “wake-up” and listen for a received signal before returning to a low current “sleep” mode. The Sleep Time can be PC programmed between 0.5 - 8 seconds. A longer sleep time will result in increased battery life, but may result in missed calls.

Busy Channel TX Inhibit(PC or FP)

If **ENABLED** this feature prevents you from talking over someone else on the same channel even if they are using a different tone code. The radio will beep a series of long, low tones that sounds like a “busy signal” when you press the **ON/PTT** button.

FCC Licensing

Except for the five (5) MURS frequencies listed on page 12, the FCC requires the owners of radios operating on these frequencies to obtain a station license before using them.

The station licensee is responsible for ensuring that transmitter power, frequency and deviation are within the limits specified by the station license. The station licensee is also responsible for proper operation and maintenance of the radio equipment. This includes checking the transmitter frequency and deviation periodically, using appropriate methods.

To get an FCC license for VHF or UHF frequencies, submit FCC application Form 601. Your Ritron dealer can help you with this process.

How to Obtain an FCC Radio License

Because your Ritron radio operates on Private Land Mobile frequencies, it is subject to the Rules and Regulations of the FCC, which requires all operators of these frequencies to obtain a station license before operating their equipment. Make application for your FCC license on FCC Forms 601, Schedules D and H, and Fee Remittance Form 159.

To have forms and instructions faxed to you by the FCC, call the FCC Fax-On-Demand system at **202-418-0177** from your fax machine; request Document numbers 3000159, 3060001, 3060003, and 3060006.

To have Document numbers 3000159, 3060001, 3060003, and 3060006 mailed to you, call the FCC Forms Hotline at **800-418-FORM (800-418-3676)**.

For help with questions concerning the license application, contact the FCC at **888-CALL-FCC (888-225-5322)** or log on at www.fcc.gov

You must decide which radio frequency(ies) you can operate on before filling out your application.

For help determining your frequencies, call Ritron at **800-USA-1-USA (800-872-1872)**.

INDUSTRY CANADA Regulations

Industry Canada requires the owners of the radios to obtain a radio license before using them.

Application forms can be obtained from the nearest Industry Canada District office.

1. Fill in the items per the instructions. If you need additional space for any item, use the reverse side of the application.
2. Use a typewriter or print legibly.
3. Make a copy for your files.
4. Prepare a check or money order to "Receiver General for Canada", for the amount listed at <http://www.ic.gc.ca/eic/site/smt-gst.nsf/eng/sf01027.html>. (Licenses are renewed annually on April 1st. Refer to the calculation for application fees for each month.)
5. Mail the completed application, along with your check or money order, to the closest Industry Canada District Office.

Notes: Fees are subject to change without notice.

Safety Standards

The FCC (with its action in General Docket 79-144, March 13, 1985) has adopted a safety standard for human exposure to radio frequency electromagnetic energy emitted by FCC regulated equipment. Ritron observes these guidelines and recommends that you do also:

- DO NOT hold the radio so that the antenna is very close to or touching exposed parts of the body, especially the face or eyes, while transmitting. Keep the radio vertical, eight inches away while talking into the front panel.
- DO NOT press the Push-To-Talk except when you intend to transmit.
- DO NOT operate radio equipment near electrical blasting caps or in an explosive atmosphere.
- DO NOT allow children to play with any radio equipment that contains a transmitting device.
- Repair of Ritron products should be performed only by Ritron authorized personnel.

Service

Federal law prohibits you from making any internal adjustments to the transmitter, and / or from changing transmit frequencies unless you are specifically designated by the licensee.

If your radio equipment fails to operate properly, or you wish to have the radio programmed, contact your local authorized dealer or Ritron.

RITRON, INC. LIMITED WARRANTY

WHAT THIS WARRANTY COVERS:

RITRON, INC. ("RITRON") provides the following warranty against defects in materials and/or workmanship in **RITRON Radios and Accessories** under normal use and service during the applicable warranty period (as stated below). "Accessories" means antennas, holsters, chargers, earphones, speaker/microphones and items contained in the programming and programming/service kits.

<u>WHAT IS COVERED</u>	<u>FOR HOW LONG</u>	<u>WHAT RITRON WILL DO</u>
OUTPOST® Callboxes	1 year*	During the first year after date of purchase, RITRON will repair or replace the defective product, at RITRON's option, parts and labor included at no charge.
Accessories	90 days*	<i>*After date of purchase</i>

WHAT THIS WARRANTY DOES NOT COVER:

- Any technical information provided with the covered product or any other RITRON products;
- Installation, maintenance or service of the product, unless this is covered by a separate written agreement with RITRON;
- Any products not furnished by RITRON which are attached or used with the covered product, or defects or damage from the use of the covered product with equipment that is not covered (such as defects or damage from the charging or use of batteries other than with covered product);
- Defects or damage, including broken antennas, resulting from:
 - misuse, abuse, improper maintenance, alteration, modification, neglect, accident or act of God,
 - the use of covered products other than in normal and customary manner or,
 - improper testing or installation;
- Defects or damages from unauthorized disassembly, repair or modification, or where unauthorized disassembly, repair or modification prevents inspection and testing necessary to validate warranty claims;
- Defects or damages in which the serial number has been removed, altered or defaced.
- Batteries if any of the seals are not intact.

IMPORTANT: This warranty sets forth the full extent of RITRON's express responsibilities regarding the covered products, and is given in lieu of all other express warranties. What RITRON has agreed to do above is your sole and exclusive remedy. No person is authorized to make any other warranty to you on behalf of RITRON. Warranties implied by state law, such as implied warranties of merchantability and fitness for a particular purpose, are limited to the duration of this limited warranty as it applies to the covered product. Incidental and consequential damages are not recoverable under this warranty (this includes loss of use or time, inconvenience, business interruption, commercial loss, lost profits or savings). Some states do not allow the exclusion or limitation of incidental or consequential damages, or limitation on how long an implied warranty lasts, so the above limitations or exclusions may not apply to you. Because each covered product system is unique, RITRON disclaims liability for range, coverage, or operation of the system as a whole under this warranty.

WHO IS COVERED BY THIS WARRANTY: This warranty is given only to the purchaser or lessee of covered products when acquired for use, not resale. This warranty is not assignable or transferable.

HOW TO GET WARRANTY SERVICE: To receive warranty service, you must deliver or send the defective product, delivery costs and insurance prepaid, within the applicable warranty period, to **RITRON, INC., 505 West Carmel Drive, Carmel, Indiana 46032, Attention: Warranty Department**. Please point out the nature of the defect in as much detail as you can. You must retain your sales or lease receipt (or other written evidence of the date of purchase) and deliver it along with the product. If RITRON chooses to repair or replace a defective product, RITRON may replace the product or any part or component with reconditioned product, parts or components. Replacements are covered for the balance of the original applicable warranty period. All replaced covered products, parts or components become RITRON's property.

RIGHTS TO SOFTWARE RETAINED : Title and all rights or licenses to patents, copyrights, trademarks and trade secrets in any RITRON software contained in covered products are and shall remain in RITRON. RITRON nevertheless grants you a limited non-exclusive, transferable right to use the RITRON software only in conjunction with covered products. No other license or right to the RITRON software is granted or permitted.

YOUR RIGHTS UNDER STATE LAW: This warranty gives you specific legal rights, and you may also have other rights which vary from state to state.

WHERE THIS WARRANTY IS VALID: This warranty is valid only within the United States, the District of Columbia and Puerto Rico.