



COMPACT ULTRA-SMALL PROFESSIONAL TWO-WAY RADIOS

- Two channels
- 2 Watts of power
- Quick-change battery
- Drop-in charge capable
- Weather scan feature (VHF only)
- Easy-to-hear, high audio output
- Built-in Quiet Call® tone feature
- Customer-selectable frequency settings

RITRON *JMX/SST* SERIES HANDHELDS OWNER'S MANUAL

TABLE OF CONTENTS

<i>DESCRIPTION</i>	<i>PAGE</i>
INTRODUCTION	
General	1
Inspection	1
Model Identification	1
ACCESSORIES	
Optional Accessories	1
FIG-1: Belt Clip Installation	1
CONTROL & OPERATION	2
FIG-2: Radio Controls and Connectors	2
OPERATION	
Weather Scan (VHF Radios Only)	3
FIG-3: To Scan Weather Frequencies	3
What The Radio Tones Mean	3
Quiet Call Tones	3
HOW TO DETERMINE FREQUENCY & TONE CODES IN YOUR JMX/ SST	
To Read Out (Beep Out) Radio Channel Contents	4
FIG-4: To Place the Radio in Program/ Readout Mode	4
FREQUENCY TABLE	5
QUIET CALL® TONE CODE TABLE	5
HOW TO PROGRAM YOUR JMX/ SST	6
PROGRAMMING	7
!! CAUTIONS — ALL RADIOS !!	7

<i>DESCRIPTION</i>	<i>PAGE</i>
BATTERIES	
FIG-5: Battery Access and Installation	8
Optional Charging Accessories	8
General	9
Charging	9
Battery Maintenance and Conditioning	9
TROUBLESHOOTING	
Notes	10
Chart	10
FCC LICENSE REQUIRED	
FCC Regulations	11
Service	11
How to Obtain an FCC Radio License	11
LIMITED WARRANTY	BACK COVER
TABLES:	
1. Programmable Frequencies and Codes	5
2. Quiet Call Codes and Frequencies	5
FIGURES:	
1. Belt Clip Installation	1
2. Radio Controls and Connectors	2
3. To Scan Weather Frequencies	3
4. To Place the Radio in Program/ Readout Mode	4
5. Battery Access and Installation	8

NOTE: Refer to pages 1 and 8 for Accessory information.

INTRODUCTION

GENERAL

This manual covers Ritron models:

JMX-152/ -452

SST-150/ -450

These radios are compact, programmable two-way handhelds designed to operate in a professional FM communications band (VHF or UHF business available).

These handhelds feature push-button operating controls, with the Push-To-Talk (PTT) and Channel buttons on one side of the radio, and the On/ Volume Up, Volume Down/ Off and monitor controls on the top. Each radio can be programmed to contain a unique set of operating frequencies and options.

All JMX/ SST radios feature quick-change battery pack and drop-in charger capabilities. See Accessories, at right.

INSPECTION

Make sure the package includes a radio, antenna, rechargeable battery pack and belt clip. Examine the equipment immediately after delivery and report any damage to your shipping company.

MODEL IDENTIFICATION

The model number on the back of the radio case indicates its operating band. A color "dot" label on the bottom of JMX radio cases also indicates the frequency. Refer to the Frequency Chart on page 5.

JMX-152 and SST-150 Series radios are designed to operate on up to two channels within any 5 MHz band between 150 and 162 MHz.

JMX-452 and SST-450 Series radios are designed to operate on up to two channels within any 10 MHz band between 450 and 470 MHz.

MODEL	BAND
JMX-152	VHF
SST-150	VHF
JMX-452	UHF
SST-450	UHF

FIG-1: BELT CLIP INSTALLATION

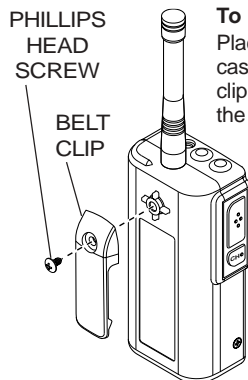

To attach the belt clip to the radio— Place the clip on the back of the radio case, aligning the screw hole in the clip with the hole in the case. Tighten the screw. See FIG-1 at left.

CAUTION:
Use only the included Phillips head screw, because a longer screw could damage radio electronics.

ACCESSORIES

OPTIONAL ACCESSORIES:

TO ORDER, CALL 1-800-USA-1-USA

- BPJS-6N** Spare/ Replacement JMX Battery
- BPS-6N-SC** Spare/ Replacement SST Battery
- AFS-150** VHF Molded Flex Antenna
- AFS-450** UHF Molded Flex Antenna
- RHD-1X** Single Ear Headset
- RHD-4X** Dual Ear Headset

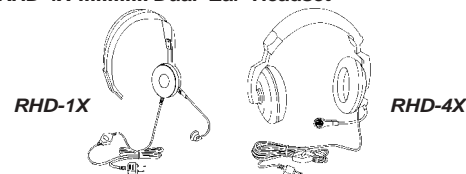

- RSM-3X** Remote Speaker Microphone

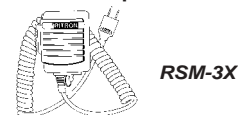

- REP-2** Low Profile Earphone
- CCL-B** Cigarette Lighter Charger
- MHS-A** Cordura Holster w/quick release
- BCJS-AD** Drop-in Charger: JMX (Overnight)



- BCPS-AD** Drop-in Charger: SST (Overnight)
- BCC-PS** Drop-in High-rate Charger/Conditioner; for SST Models only

NOTE: Call RITRON for a complete listing.

CONTROL & OPERATION

1 ANTENNA

The flexible antenna radiates and receives radio signals. Screw the antenna base all the way into the threaded bushing on top of the radio.

NOTE: Use only the type of antenna furnished with the radio. VHF and UHF antennas are not interchangeable.

2 ON/ VOLUME UP

To switch the unit On, press the On/ Volume Up button; the speaker will emit a brief confirmation tone. Once the radio is On, press this button to increase volume.

3 VOLUME DOWN/OFF

Press the Volume Down/ Off button to decrease volume. To switch Off the unit, press and hold this button until the speaker emits a double beep.

4 PUSH-TO-TALK SWITCH (PTT)

Press and hold the PTT when transmitting; release it to receive.

5 CHANNEL SELECT

Pressing this button changes the channel, and the radio beeps the channel number.

6 BATTERY ACCESS DOOR (CASE BOTTOM)

The battery access door may be removed to access the battery pack. Refer to Battery Access & Installation, FIG-5, page 8.

7 JACK COVER

This rubber cover seals out dust and moisture, etc. Snap the cover into the audio accessory jack and charge jack openings when the jacks are not in use.

8 AUDIO ACCESSORY JACK

The audio accessory jack is used to plug in earphone options, and, in conjunction with the charge jack, to connect an optional remote speaker/ microphone or a single- or dual-ear headset.

9 CHARGE JACK

The battery pack may be charged through this jack using the supplied RITRON charger cube. Refer to Accessories, page 1.

10 SPEAKER

The speaker, located behind the front grille, allows you to hear calls on your channel.

11 MICROPHONE

The microphone allows your voice to be heard in transmissions to other radios. Speak in a normal tone; shouting does not improve your listener's reception.

12 DROP-IN CHARGING CAPABILITY

Two contacts, in the bottom of the radio, permit charging the battery pack with an optional drop-in charger. Refer to Optional Charging Accessories, page 8.

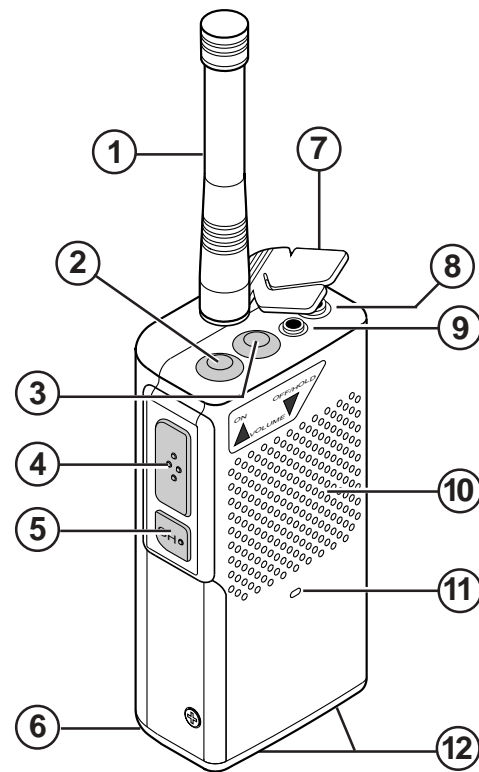

FIG-2: RADIO CONTROLS & CONNECTORS

IMPORTANT: CHARGE THE BATTERY PACK BEFORE using the radio for the first time. Refer to Batteries, pages 8 and 9.

OPERATION

WEATHER SCAN (VHF RADIOS ONLY)

TO SCAN STANDARD U.S. WEATHER FREQUENCIES and hear weather forecasts, follow the steps in FIG-3 below. To resume normal two-way operation, turn the radio off, then on again.

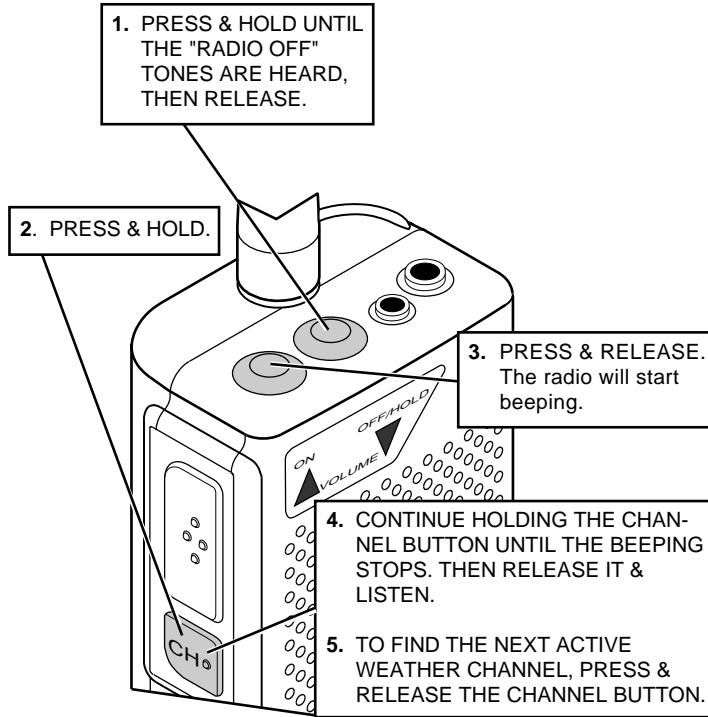

FIG-3: TO SCAN WEATHER FREQUENCIES

WHAT THE RADIO TONES MEAN

POWER ON/ SELF TEST "OK"

When it is first turned on, the radio runs a quick "self test" to confirm basic functions. The radio then emits a brief "confirmation tone" to indicate it is ready to use.

ERROR TONES

In the Program/ Readout Mode, the radio will emit an Error Tone if a programming error is made.

If the self test detects a diagnostic error, an alternating error tone sounds. Turn the radio off, then on again. Consult a Ritron Dealer, or Ritron, Inc. with any problem you cannot correct.

CHANNEL SELECT TONE

When you press the channel select button, the radio "beeps" the number of times equal to the channel number selected.

QUIET CALL SQUELCH TONES

If you press both volume buttons simultaneously, a single beep indicates Quiet Call squelch is on; a "double beep" means it is off.

DEAD BATTERY TONE

When the battery charge drops below the required operating voltage, the radio emits a long, low tone and turns itself off. If you turn it back on, the radio will beep and shut itself off again. Recharge the battery.

PROGRAM/ READOUT MODE TONE

Placing the radio in Program/ Readout Mode causes it to beep rapidly for about three seconds, then to "triple beep." This series of beeps indicates the radio is ready for you either to program, or to read out the programmed contents. See pages 4 and 6.

WEATHER SCAN TONE: VHF Radios Only

The radio beeps when you activate the weather scan feature, and stops when it is ready to scan standard U.S. weather frequencies.

TRANSMITTER TIME-OUT

A low, then a high tone sound and the transmitter automatically shuts off if you hold down the PTT button continuously for 60 seconds. The radio switches to "receive." Dealers can turn this feature off.

QUIET CALL TONE CODES (Interference Eliminator Codes)

Tone codes filter out static, noise and reduce unwanted "chatter" on radio channels. When you operate on a frequency with a tone code, you screen out most interference. This allows you to communicate with less interference and to hear only those users in your radio group.

IMPORTANT: All radios in the talk group must operate on the same frequency and tone code.

HOW TO DETERMINE FREQUENCIES & TONE CODES IN YOUR JMX/ SST

IMPORTANT:

To talk to other users in your group, all radios must be set to the same frequency and Quiet Call tone code.

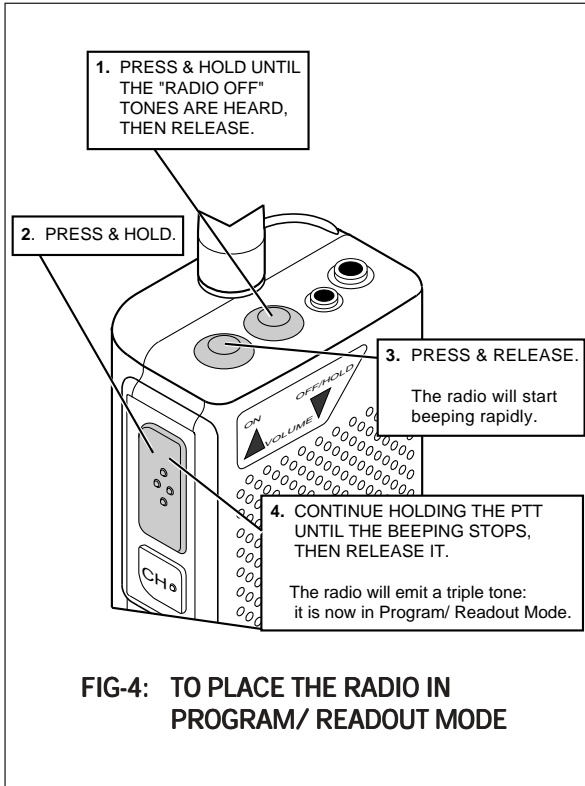

FIG-4: TO PLACE THE RADIO IN PROGRAM/ READOUT MODE

TO READ OUT (BEEP OUT) RADIO CHANNEL CONTENTS

- To enter the Programming/ Readout Mode, refer to FIG-4 at left.
- Press and release the On/ Volume Up button. The radio will begin to emit a series of beeps; each series of beeps is equal to one digit of each two-digit frequency code or Quiet Call tone code programmed into the radio; **see Tables 1 and 2, opposite.**
- Count the beeps in each series. Record the digits below.
Examples: 2 beeps = 2; 10 beeps = 0 (zero).
- Turn the radio off.

NOTES: The radio pauses and emits a low tone at the end of each series of beeps, separating one digit from the next. The radio emits a triple tone when the readout (beep out) process is complete.

CHANNEL 1:

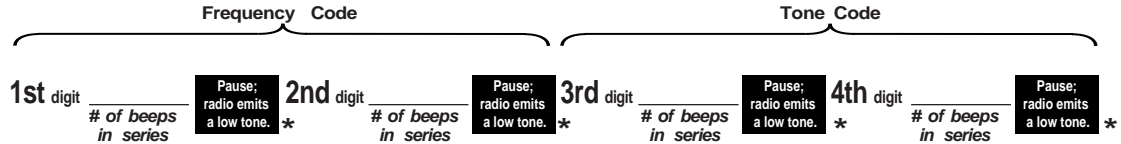

CHANNEL 2:

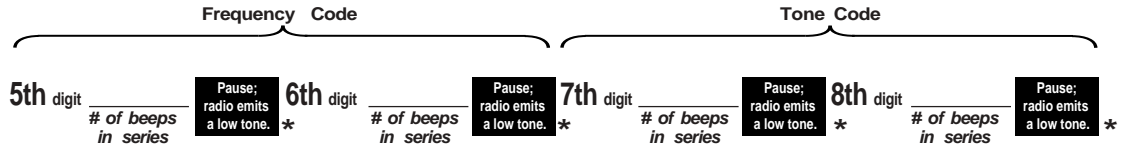

- NOTES:**
- Ten (10) beeps = 0 (zero).
 - The radio will beep out "44" as a tone code if it has been programmed for "No Tone."
 - A radio that was PC-programmed with **any frequency not listed** in Table 1, page 5, will emit meaningless beeps on contents readout.
 - A radio with identical codes in both channels will beep out only one frequency and one QC code.
 - Ritron JMX/ SST radios can have a different Quiet Call tone programmed into each channel.
- * The radio pauses to emit a low tone at the end of each beep series.

FREQUENCY TABLE

TABLE 1: PROGRAMMABLE FREQUENCY CODES

JMX/ SST BEEP OUT/ PTT CLICK FREQ. CODE	VHF Business Band (Models JMX-152 & SST-150)		JMX/ SST BEEP OUT/ PTT CLICK FREQ. CODE	UHF Business Band (Models JMX-452 & SST-450)	
	MHz	Frequency Color		MHz	Frequency Color
01	154.600 ...	Green Dot	01	467.7625	J
02	154.570 ...	Blue Dot	02	467.8125	K
03	151.625 ...	Red Dot *	03	464.5500	Yellow Dot *
04	151.955 ...	Purple Dot	04	464.5000	Brown Dot *
05	151.925		05	467.8500	Silver Star
06	154.540		06	467.8750	Gold Star
07	154.515		07	467.9000	Red Star
08	154.655		08	467.9250	Blue Star
09	151.685		09	469.2625	
10	151.715		10	462.5750	White Dot
11	151.775		11	462.6250	Black Dot
12	151.805		12	462.6750	Orange Dot
13	151.835		13	464.3250	
14	151.895		14	464.8250	
15	154.490		15	469.5000	
16	151.655		16	469.5500	
17	151.745		17	463.2625	
18	151.865		18	464.9125	
19	-----		19	464.6000	
20	-----		20	464.7000	

* Itinerant frequency

* Itinerant frequency

NOTE: Programming ten (10) PTT clicks = the digit 0 (zero).
Hearing (10) ten beeps on readout = the digit 0 (zero).

QUIET CALL® (TONE) CODE TABLE**

TABLE 2: TONE CODES

JMX/ SST BEEP OUT/ PTT CLICK CODE	Freq. (Hz)	Other Radio Brands		JMX/ SST BEEP OUT/ PTT CLICK CODE	Freq. (Hz)	Other Radio Brands	
		Tone Code	Freq. (Hz)			Tone Code	Freq. (Hz)
01	67.0	XZ	67.0	27	167.9	6Z	167.9
02	71.9	XA	71.9	28	173.8	6A	173.8
03	74.4	WA	74.4	29	179.9	6B	179.9
04	77.0	XB	77.0	30	186.2	7Z	186.2
05	79.7	SP	79.7	31	192.8	7A	192.8
06	82.5	YZ	82.5	32	203.5	M1	203.5
07	85.4	YA	85.4	33	210.7	--	210.7
08	88.5	YB	88.5	34	218.1	--	218.1
09	91.5	ZZ	91.5	35	225.7	--	225.7
10	94.8	ZA	94.8	36	233.6	--	233.6
11	97.4	ZB	97.4	37	241.8	--	241.8
12	100.0	1Z	100.0	38	250.3	--	250.3
13	103.5	1A	103.5	39	69.4	--	69.4
14	107.2	1B	107.2	40	159.8	--	159.8
15	110.9	2Z	110.9	41	165.5	--	165.5
16	114.8	2A	114.8	42	171.3	--	171.3
17	118.8	2B	118.8	43	177.3	--	177.3
18	123.0	3Z	123.0	44***	No Tone	--	No Tone
19	127.3	3A	127.3	45	183.5	--	183.5
20	131.8	3B	131.8	46	189.9	--	189.9
21	136.5	4Z	136.5	47	196.6	--	196.6
22	141.3	4A	141.3	48	199.5	--	199.5
23	146.2	4B	146.2	49	206.5	--	206.5
24	151.4	5Z	151.4	50	229.1	--	229.1
25	156.7	5A	156.7	51	254.1	--	254.1
26	162.2	5B	162.2				

** Interference Eliminator codes

*** Refer to Note 2 on both pages 4 & 6.

HOW TO PROGRAM YOUR JMX/ SST

To match other radios, the owner can select FREQUENCY and QUIET CALL TONE CODES from tables factory-programmed into the radio. **See Tables 1 and 2, page 5.**

1. Choose your frequency codes (Table 1), and QC codes, if desired (Table 2). Programming channel 2 is optional. **Note that each code consists of two digits.** Write down the digits of the codes you are going to program in the space provided below.

CHANNEL 1:

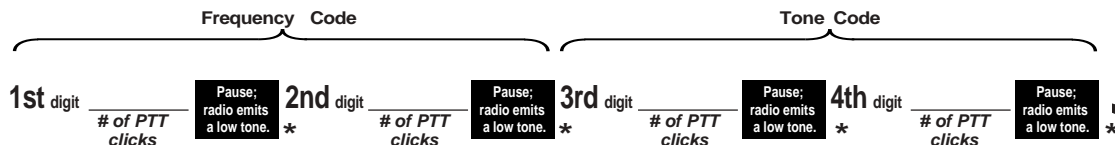

CHANNEL 2:

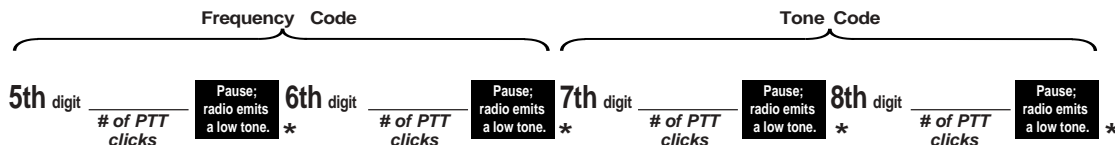

Continue the programming sequence if you are entering digits for Channel 2.

2. Follow the instructions in FIG-4, page 4, to place the radio in the Program/ Readout Mode.
3. Enter codes in the sequence shown in Step 1 by clicking the PTT the number of times equal to each digit of the code.
EXAMPLE: Two-digit code "04" — click the PTT ten times to program "0", and pause. The radio emits a low tone. Then click the PTT four times to program "4", and pause. The radio emits a low tone.
4. When all the digits are programmed, press and release On/ Volume Up to save your programming; the radio emits a triple beep.
NOTE: An error tone will sound if you attempt to save an incorrect digit. Turn the radio off, check the digits you are attempting to enter, then start over at Step 2.
5. Turn the radio off and then on again — the radio is now ready to use

NOTES: 1. Ten (10) PTT clicks = 0 (zero).

2. Program "44" to enter "No Code" for Quiet Call. **You must enter "44" to match radios not having tone codes.**
3. IF YOU MAKE A PTT CLICK ERROR, turn the radio off then on, and start over.
4. If the radio does not emit a confirming triple tone when you attempt to enter Program/ Readout Mode, the radio was factory or dealer customized to disable programming. Consult the radio owner or your dealer.
5. Refer to Frequency and Tone Code (Quiet Call®) tables on page 5.

PROGRAMMING

TO ADJUST RECEIVER SQUELCH SENSITIVITY

JMX/ SST Series radios can be adjusted for squelch sensitivity to reduce distant "co-channel" or other interference on **channels not programmed with Quiet Call**. You can also adjust the squelch sensitivity to prevent hearing messages from a distant radio group using the same frequency and QC code as your group.

1. Put the radio in Program/ Readout Mode; see FIG-4 opposite.
2. Enter an "8" by pressing the PTT eight (8) times without pausing.
3. Press the PTT to enter a single digit factor from "1" to "3". Press it the number of times equal to the factor. The higher the number, the more interference will be reduced and the stronger the incoming radio signal must be to be heard.
 - 1 = *maximum sensitivity (factory setting)*
 - 2 = *reduced sensitivity*
 - 3 = *minimum sensitivity*
4. Press and release On/ Volume Up to save the change.

NOTE: The adjust receiver squelch sensitivity feature is for user convenience. To prevent interference, Ritron recommends programming a different Quiet Call code into the channel.

!! CAUTIONS — ALL RADIOS !!

OBSERVE CAUTION IN THE FOLLOWING ENVIRONMENTS TO MAXIMIZE THE LIFE OF YOUR RADIO EQUIPMENT:

MOISTURE: JMX/ SST Series radios are not waterproof. DO NOT directly expose them to rain or excessive moisture.

CHEMICALS: Detergents, alcohol, aerosol sprays or petroleum products can damage the radio case. DO NOT use petroleum solvents of any kind; use a soft cloth moistened with water to clean the case.

EXTREME HEAT: High temperatures can damage the battery and other components. DO NOT expose the units to extreme heat or leave them in direct sunlight.

LOW TEMPERATURES: The capacity of the NiCad battery is greatly reduced in extreme cold. When using the unit in very cold environments, periodically warm the radio under your coat.

EXCESSIVE TRANSMISSIONS: Maximum drain on battery power occurs when you are transmitting. DO NOT hold the Push-To-Talk switch down longer than necessary during transmission intervals. DO NOT reduce battery service life by attempting to power a radio with a depleted battery; always charge batteries overnight after each day of use.

VIBRATION/ SHOCK: Although your JMX/SST Series radio is designed to be rugged, it will not survive excessive abuse. Avoid dropping the radio.

NOTE: The optional MH-A holster provides added protection from weather and shock.

BATTERIES

FIG-5: BATTERY ACCESS & INSTALLATION

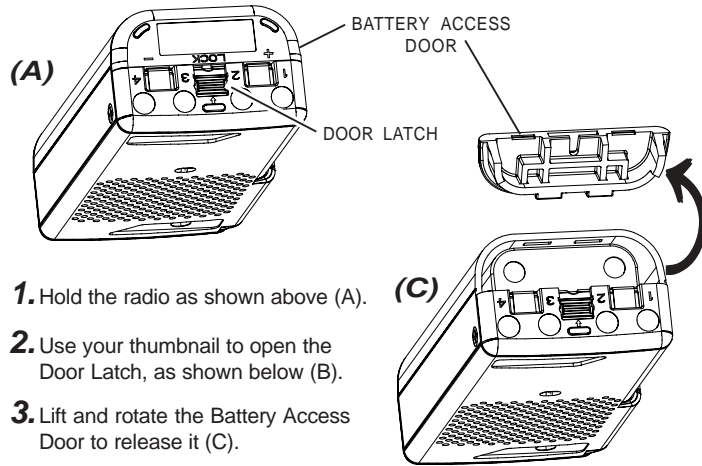

1. Hold the radio as shown above (A).
2. Use your thumbnail to open the Door Latch, as shown below (B).
3. Lift and rotate the Battery Access Door to release it (C).

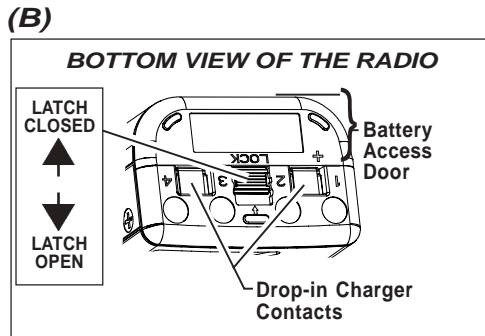

4. Use the Pull-tab to pull the battery pack out of the case (D).
5. Insert the replacement battery pack, being certain to POSITION IT RELATIVE TO THE CASE AS SHOWN IN (D). Push the Battery Pack in as far as possible.
6. Replace the Battery Access Door. Secure it by closing the Door Latch as shown in (B).
7. Be certain to firmly lock the Door Latch, as shown in (B).

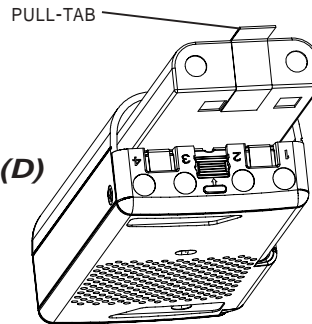

OPTIONAL CHARGING ACCESSORIES:

Spare/ Replacement Battery Pack



Drop-in Battery Charger with Spacer

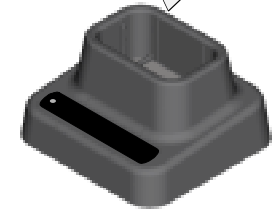

JOBKOM JMX Accessories:

- BPJS-6N** 700 mAH Spare Battery Pack
- BCJS-AD** Drop-in Charger Adapter

PATRIOT SST Accessories:

- BPS-6N-SC** 800 mAH Spare Battery Pack
- BPS-6N-MH** 1500 mAH Spare Battery Pack
- BCPS-AD** Drop-in Charger Adapter
- BCC-PS** Drop-in Charger/ Conditioner

BATTERIES

CAUTION: Use only RITRON-supplied chargers; using other chargers may cause fire or explosion, or otherwise damage the radio.

GENERAL

The JMX/ SST Series radio is powered by a rechargeable battery pack.

CHARGING

Because the battery pack loses its charge during storage and shipment, fully charge it before first use. To ensure peak radio performance for the next day, charge the battery overnight after each day of use. It completely charges in about ten hours.

TO CHARGE THE BATTERY WITH A RITRON CUBE CHARGER

Plug the charger cord into the charge jack (marked "CHG") on top of the radio. Then plug the cube into an 110 VAC outlet. The green lamp lights while the battery is charging, and should go out only when the cube or cord is unplugged.

TO CHARGE THE BATTERY WITH A RITRON DROP-IN CHARGER

Two charger contacts, visible through the radio case bottom, permit charging the battery with an optional Ritron drop-in charger. The battery pack may be either removed from the radio case for charging, or charged inside the radio case.

Each drop-in charger comes with a spacer to permit charging a "spare" battery while the radio is being used.

To use the drop-in charger, plug it into a 110 VAC outlet. Set either the radio with the battery installed, or only the battery with the battery spacer, into the charger. Refer to the illustration in Optional Accessories, opposite. Each battery contact must rest on a charger contact pin.

NOTE: *Battery pack life averages one year. Follow these guidelines to maximize service life:*

- CONDITION battery packs once a month as directed in Battery Maintenance & Conditioning, at right.
- CONDITION batteries that are run down.
- CHARGE batteries for 16 hours before storage, and for 16 hours once a month thereafter.
- DO NOT overcharge batteries. Unplug the cube charger after 16 hours to avoid overcharging.
- DO NOT charge batteries in temperatures colder than about 45°F. Charging batteries in temperatures above 95°C. does not harm them, but can reduce charge capacity.

BATTERY MAINTENANCE & CONDITIONING

Due to the extended run time of the JMX/ SST Series radios, some users may never fully discharge the NiCad battery pack during normal use. Achieve maximum battery life by fully discharging the battery periodically to condition it.

After exposing the battery pack to many cycles of not fully discharging it before recharging, the radio may exhibit reduced battery capacity. This reduced capacity is evident when, after several hours of use, battery voltage drops while the radio is transmitting, causing the radio to emit a dead battery warning tone and shut itself off.

Condition battery packs by the following procedure as either a preventive measure, or if you suspect reduced capacity:

TO CONDITION THE BATTERY PACK:

1. Use your radio throughout a normal work day without charging.
2. • Press and hold the On/ Volume Up and Volume Down/ Off buttons simultaneously for 8 seconds to place the radio in "open squelch" mode.
 - Release both buttons when you hear the radio beep rapidly; it will then emit a loud "rushing" noise. Press On/ Volume Up to maximize this noise.
3. • Put the radio away in a secure place (possibly a desk drawer), where nothing can press against the buttons to accidentally turn it off or cause it to transmit. Allow the radio to run until it shuts off when the battery is completely discharged. A typical battery pack may require about 8 hours to completely discharge.
4. • When the radio has shut off, charge it overnight for 12-14 hours. The battery will be ready for use with renewed capacity.

NOTE: A new battery must be charged and discharged several times before it can reach its maximum charge capacity.

TROUBLESHOOTING

NOTES

- Try a battery pack from a working radio. If the radio in question works with that pack, the original battery is suspect.
 - Charge the suspect battery as recommended in this manual. If this original battery cannot power the radio, try charging it again with another charger. If the battery still doesn't hold a charge, the pack should probably be replaced.
 - If the battery appears to be "good" after using the second charger, the first charger may be faulty. Contact a dealer or Ritron about an accessory that is not operating properly.
- Reception can often be improved if you relocate by a short distance. This effect is more noticeable inside buildings.
 - The range for JMX/ SST radios is about two miles, line-of-sight.
- If your radio does not detect calls from other radios on the channel, turn off Quiet Call by pressing and holding both volume buttons at the same time — a double beep indicates Quiet Call is off.
- Without use of a repeater: To hear a call, select a channel programmed to receive the caller's transmit frequency. To call another unit, select a channel programmed to transmit the other radio's receive frequency.
 - Using a repeater: A radio channel can hold two separate operating frequencies, one for receive and one for transmit. Your channel must work with the repeater's transmit and receive frequencies.
- Maximum power drain occurs when the radio transmits, so don't hold down the PTT more than needed to transmit.
 - Battery power is used while the handheld is left on to receive calls. If practical, switch off the unit.
- Battery capacity is greatly reduced in extreme cold.
 - To use the radio in very cold weather, periodically warm it under your coat if possible.
 - An optional remote speaker/ microphone allows keeping the radio under your coat while transmitting and receiving.
- To "talk" with each other, radios must be programmed identically for Quiet Call code, as well as frequency. Each code is unique; radios respond only to the code programmed.
 - Press and hold both volume buttons at the same time.
 - A single beep indicates Quiet Call squelch is on.
 - A double beep indicates Quiet Call squelch is off.

CHART

If you have trouble operating the handheld, review the Control & Operation, pages 2 and 3. If you think the radio is malfunctioning, check the list below.

Problem	Possible Solutions
GENERAL	
The radio does not work at all.	Make sure that the battery is installed correctly, as shown in FIG-5. page 8. Recharge or replace the battery. (See pages 8 & 9.)
Operating features do not work exactly as expected.	The radio has been dealer programmed for customized operation. (Consult dealer.)
Reception is poor.	Move to a different location. (See Note 2.) Confirm the proper antenna is connected to the radio. (See page 2, "Antenna.")
You cannot hear calls from other radios.	Turn off Quiet Call (coded) squelch. (See Note 3.) Ensure radio receives on the same frequency as the caller transmits. (See Note 4.) Recharge the battery. (See Note 1.)
Your calls cannot be heard in other radios.	Make sure that your radio transmits on the receive frequency of the radio(s) you want to call. (See Note 4.) Recharge the battery.
BATTERY	
Battery loses charge sooner than expected.	Review battery charging instructions, page 9. Conserve the battery. (See Note 5.) If the radio is used in extreme cold, warm the radio under your coat. (See Note 6.) Replace the battery; see FIG-5, page 8. (See Note 1.)
ERRORTONES	
An error tone sounds when the radio is first switched on.	See "Error Tones" on page 3.
An error tone occurs while transmitting.	Refer to "Transmitter Time-Out," page 3.
QUIET CALL	
You cannot screen out calls from users outside of your Quiet Call group.	Make sure that the channel is programmed with Quiet Call. Activate coded squelch. (See Note 7.)
You cannot hear Quiet Call messages while in Quiet Call (coded) squelch.	Confirm that the channel is programmed to detect the same code as the calling radio(s) transmits. (See Note 7.)
Others in your Quiet Call group cannot hear your Quiet Call messages.	Verify that you transmit the same code as the radio(s) you call are programmed to detect. (See Note 7.)

FCC LICENSE REQUIRED

FCC REGULATIONS

LICENSING —

The FCC requires the owners of the radios to obtain a station license before using them.

The station licensee is responsible for ensuring that transmitter power, frequency and deviation are within the limits specified by the station license. The station licensee is also responsible for proper operation and maintenance of the radio equipment. This includes checking the transmitter frequency and deviation periodically, using appropriate methods.

To get a FCC license for VHF or UHF frequencies, submit FCC application Form 600 as indicated in the block at right. Your Ritron dealer can help you with this process.

SAFETY STANDARDS —

The FCC (with its action in General Docket 79-144, March 13, 1985) has adopted a safety standard for human exposure to radio frequency electromagnetic energy emitted by FCC regulated equipment. Ritron observes these guidelines and recommends that you do also:

- DO NOT hold the radio so that the antenna is very close to or touching exposed parts of the body, especially the face or eyes, while transmitting. Keep the radio vertical, two to three inches away while talking into the front panel.
- DO NOT press the Push-To-Talk except when you intend to transmit.
- DO NOT operate radio equipment near electrical blasting caps or in an explosive atmosphere.
- DO NOT allow children to play with any radio equipment that contains a transmitting device.
- Repair of Ritron products should be performed only by Ritron authorized personnel.

SERVICE

Federal law prohibits you from making any internal adjustments to the transmitter, and/ or from changing transmit frequencies unless you are specifically designated by the licensee.

If your radio equipment fails to operate properly, or you wish to have the radio programmed, contact your authorized dealer or Ritron.

HOWTOOBTAINANFCCRADIOLICENSE

Federal Communications Commission (FCC) Licensing Information

Because your Ritron radio operates on Private Land Mobile frequencies, it is subject to the Rules and Regulations of the FCC, which requires all operators of these frequencies to obtain a station license before operating their equipment. Make application for your FCC license on FCC Forms 600 and 159.

*To have forms and instructions faxed to you by the FCC, call the **FCC Fax-On-Demand** system at **202-418-0177** from your fax machine; request Document 000600 & Form 159.*

*To have Document 000600 & Form 159 mailed to you, call the **FCC Forms Hotline** at **800-418-FORM** (800-418-3676).*

*For help with questions concerning the license application, contact the FCC at **888-CALL-FCC** (888-225-5322).*

*You must decide which radio frequency(ies) you can operate on before filling out your application; refer to Table 1 on page 5 of this manual. For help determining your frequencies, call Ritron at **800-USA-1-USA** (800-872-1872).*

RITRON, INC. LIMITED WARRANTY

WHAT THIS WARRANTY COVERS

RITRON, INC. ("RITRON") provides the following warranty against defects in materials and/or workmanship in **RITRON Radios, Rechargeable Batteries and Accessories** under normal use and service during the applicable warranty period (as stated below). "Accessories" means antennas, holsters, chargers, earphones, speaker/microphones and items contained in the programming and programming/service kits. Rechargeable batteries will be replaced during the applicable warranty period only if leakage occurs or the batteries drop below 75% of rated capacity.

WHAT IS COVERED	FOR HOW LONG	WHAT RITRON WILL DO
Portable JMX/ SST Series Radios	1 year*	During the first year after date of purchase, RITRON will repair or replace the defective product, at RITRON's option, parts and labor included at no charge.
RITRON Rechargeable Batteries	1 year*	RITRON will replace the defective battery
Accessories	90 days *	* <i>After date of purchase</i>

WHAT THIS WARRANTY DOES NOT COVER:

- Any technical information provided with the covered product or any other RITRON products;
- Installation, maintenance or service of the product, unless this is covered by a separate written agreement with RITRON;
- Any products not furnished by RITRON which are attached or used with the covered product, or defects or damage from the use of the covered product with equipment that is not covered (such as defects or damage from the charging or use of batteries other than with covered product);
- Defects or damage, including broken antennas, resulting from:
 - misuse, abuse, improper maintenance, alteration, modification, neglect, accident or act of God,
 - the use of covered products other than in normal and customary manner or,
 - improper testing or installation;
- Defects or damages from unauthorized disassembly, repair or modification, or where unauthorized disassembly, repair or modification prevents inspection and testing necessary to validate warranty claims;
- Defects or damages in which the serial number has been removed, altered or defaced.
- Batteries if any of the seals are not intact.

IMPORTANT: This warranty sets forth the full extent of RITRON's express responsibilities regarding the covered products, and is given in lieu of all other express warranties. What RITRON has agreed to do above is your sole and exclusive remedy. No person is authorized to make any other warranty to you on behalf of RITRON. Warranties implied by state law, such as implied warranties of merchantability and fitness for a particular purpose, are limited to the duration of this limited warranty as it applies to the covered product. Incidental and consequential damages are not recoverable under this warranty (this includes loss of use or time, inconvenience, business interruption, commercial loss, lost profits or savings). **Some states do not allow the exclusion or limitation of incidental or consequential damages, or limitation on how long an implied warranty lasts, so the above limitations or exclusions may not apply to you. Because each covered product system is unique, RITRON disclaims liability for range, coverage, or operation of the system as a whole under this warranty.**

WHO IS COVERED BY THIS WARRANTY

This warranty is given only to the purchaser or lessee of covered products when acquired for use, not resale. This warranty is not assignable or transferable.

HOW TO GET WARRANTY SERVICE

To receive warranty service, you **MUST** deliver or send the defective product, delivery costs and insurance prepaid, within the applicable warranty period, to RITRON, INC., 505 West Carmel Drive, Carmel, Indiana 46032, Attention: Warranty Department.

Please point out the nature of the defect in as much detail as you can. **You MUST retain your sales or lease receipt (or other written evidence of the date of purchase) and deliver it along with the product.** If RITRON chooses to repair or replace a defective product, RITRON may replace the product or any part or component with reconditioned product, parts or components. Replacements are covered for the balance of the original applicable warranty period. All replaced covered products, parts or components become RITRON's property.

RIGHTS TO SOFTWARE RETAINED

Title and all rights or licenses to patents, copyrights, trademarks and trade secrets in any RITRON software contained in covered products are and shall remain in RITRON. RITRON nevertheless grants you a limited non-exclusive, transferable right to use the RITRON software only in conjunction with covered products. No other license or right to the RITRON software is granted or permitted.

YOUR RIGHTS UNDER STATE LAW

This warranty gives you specific legal rights, and you may also have other rights which vary from state to state.

WHERE THIS WARRANTY IS VALID

This warranty is valid only within the United States, the District of Columbia and Puerto Rico.