

PATRIOT®

PATRIOT® SST "FOUR SERIES" OWNER'S MANUAL



"FOUR SERIES" HANDHELDS COMPACT ULTRA-SMALL PROFESSIONAL TWO-WAY RADIOS

- Ten-channel capability
- Easier, enhanced programming method
- 2, 3, and 4 Watt models
- Quick-change battery
- Drop-in charge capable
- Weather scan  feature (VHF only)
- Channel scan
- Easy-to-hear, high audio output
- Built-in Quiet Call® Interference Eliminator
- Digital Quiet Call® Interference Eliminator



**MADE IN THE
USA**

ACCESSORIES



RHD-1X
Single Ear Headset



RHD-6X
Behind-the-head Earset



RHD-4X
Dual Ear Headset



RHD-5X
Over-the-ear Earset



RSM-3X
Remote Speaker Mic

OPTIONAL ACCESSORIES:

TO ORDER, CALL 800-USA-1-USA.

BPS-6N-SC Spare/ Replacement SST Battery
BPS-6N-MH Replacement High Capacity Battery

AFS-150 VHF Molded Flex Antenna
AFS-450 UHF Molded Flex Antenna

RHD-1X Single Ear Headset
RHD-4X Dual Ear Headset
RHD-5X Lightweight Over-the-ear Earset w/ In-line PTT
RHD-6X Lightweight Behind-the-head Earset w/ In-line PTT

RSM-3X Remote Speaker Microphone
REP-2 Low Profile Earphone

CCL-B Cigarette Lighter Charger

MHS-A Cordura Holster w/quick release

BCPS-4AD 4-Well Drop-in Charger: SST
BCPS-AD Single-Well Drop-in Charger: SST (Overnight)
BCC-PS Drop-in High-rate Charger/
Conditioner; for SST Models only

Call RITRON for complete listings



BCPS-AD
Single-Well Drop-in Charger



BPS-6N-SC/BPS-6N-MH
Spare Battery



BCPS-4AD
4-Well Drop-in Charger



MHS-A
Swivel Holster

The NEW Patriot SST "Four Series" models contain updated programming features, and program differently than other SST portables. These radios provide more channels and feature Digital Coded Squelch and Channel Scan capability.

www.TwoWayRadioEquipment.com | (800) 878-7829 | Sales@TwoWayRadioEquipment.com
Have questions? Call **800-USA-1-USA** (800-872-1872) or visit our website at www.ritron.com

TABLE OF CONTENTS

<u>DESCRIPTION</u>	<u>PAGE</u>
ACCESSORIES	
Optional Accessories	ii
INTRODUCTION	
Features	1
"Four Series" Model Numbers	1
Inspection	1
FIG-1: Belt Clip Installation	1
CONTROL & OPERATION	2
FIG-2: Radio Controls and Connectors	2
OPERATION	
On-off/ Volume	3
Channel Selection	3
Receive	3
Selective Signaling Squelch	3
Monitor	3
Quiet Call Tone Codes (Interference Eliminator Codes)	3
Transmit	3
Radio Alert Tones	4
Optional Alert Tones	4
Weather Scan (VHF Radios Only)	4
FIG-3: To Scan Weather Frequencies	4
SCAN CHANNEL OPERATION	
How Scanning Works	5
Priority Scanning	5
Busy Channel Delete	5
Last Channel Scanned Alert Tone	5
RADIO PROGRAMMING	5
INTERFERENCE ELIMINATOR TONE CODES	
TABLE 2: Programmable QC (Quiet Call®) Tone Codes	6
TABLE 3: Programmable DQC (Digital Quiet Call®) Tone Codes ...	6

NOTE: Refer to pages ii and 8 for Accessory information.

<u>DESCRIPTION</u>	<u>PAGE</u>
!! CAUTIONS — ALL RADIOS !!	
Observe Caution in the Following Environments to Maximize the Life of Your Radio Equipment	7
Exposure to Radio Frequency Energy	7
BATTERIES	
FIG-4: Battery Access and Installation	8
Optional Charging Accessories	8
Batteries	9
Charging	9
General	9
Battery Maintenance and Conditioning	9
TROUBLESHOOTING	
Notes	10
Chart	10
FCC LICENSE REQUIRED	
FCC Regulations	11
Service	11
How to Obtain an FCC Radio License	11
LIMITED WARRANTY	INSIDE BACK COVER
TABLES:	
1. Quiet Call Codes and Frequencies	5
2. Digital Quiet Call Codes and Frequencies	5
FIGURES:	
1. Belt Clip Installation	1
2. Radio Controls and Connectors	2
3. To Scan Weather Frequencies	4
4. Battery Access and Installation	8

INTRODUCTION

FEATURES

This manual covers the Ritron SST "Four Series" radios.

These radios are compact, programmable two-way handhelds designed to operate in a professional FM communications band (VHF or UHF business available). Each radio is equipped with these features:

- **Push-button operating controls.** The Push-To-Talk (PTT) and Channel buttons are on one side of the radio, and the On/ Volume Up, Volume Down/ Off and monitor controls on the top.
- **Quick-change battery pack and drop-in charger capabilities.** See Accessories on the previous page.
- **Up to 10-channel capability.** Each channel can be programmed to contain a unique set of operating frequencies and options.
- **QC (Quiet Call) and DQC (Digital Quiet Call) interference eliminator codes.** Each channel can be programmed from a list of 51 QC sub-audible codes or 83 DQC digital privacy codes.
- **Channel scanning.** A scan channel can be created that allows selective scanning of the other channels programmed into the radio. The scan channel has many features, including Priority Scanning and Busy Channel Delete.
- **Wide or narrow band operation.** Each channel is programmable for wide or narrow band transmit operation.
- **High or low transmit power.** Each channel can be programmed for high or low transmit power to satisfy your needs for extended range or battery conservation. (This option is not available on the SST-446XP)
- **A full line of radio accessories.** Ritron offers a complete line of accessories to accommodate your specific requirements. (See page ii for Accessories)

"FOUR SERIES" MODEL NUMBERS

VHF

MODEL

SST-144 (Patriot) (4-Watt, 4 Channel)

UHF

MODEL

SST-446XP (Patriot) (2-Watt, 4 Channel)

SST-444 (Patriot) (3-Watt, 4 Channel)

The model number located on the back of the radio case indicates its operating band.

VHF radios are designed to operate on up to ten channels within the 5 MHz band between factory standard 150 and 155 MHz.

UHF radios are designed to operate on up to ten channels within the 10 MHz band between factory standard 460 and 470 MHz.

INSPECTION

Make sure the package includes a radio, antenna, rechargeable battery pack and belt clip. Examine the equipment immediately after delivery and report any damage to your shipping company.

FIG-1: BELT CLIP INSTALLATION

To attach the belt clip to the radio:

Place the clip on the back of the radio case, aligning the screw hole in the clip with the hole in the case. Tighten the screw. See FIG-1 below.

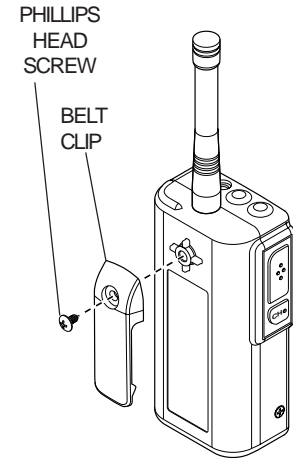

CAUTION:

Use only the included Phillips head screw, because a longer screw could damage radio electronics.

CONTROL & OPERATION

1 ANTENNA

The flexible antenna radiates and receives radio signals. Screw the antenna base all the way into the threaded bushing on top of the radio.

NOTE: Use only the type of antenna furnished with the radio. VHF and UHF antennas are not interchangeable.

2 ON/VOLUME UP

To switch the unit On, press the On/Volume Up button; the speaker will beep a number of times equal to the channel. If the radio turns on to the Scan Channel it will emit the Resume Scan Beep. Once the radio is On, press this button to increase volume.

3 VOLUME DOWN/OFF

Press the Volume Down/Off button to decrease volume. To switch Off the unit, press and hold this button until the speaker emits a double beep.

4 PUSH-TO-TALK SWITCH (PTT)

Press and hold the PTT when transmitting; release it to receive.

5 CHANNEL SELECT

Press the button once and the radio will beep a number of times equal to the current channel number. Pressing the button again within 3 seconds will increment the channel and the radio will beep the new channel. When the Scan Channel is selected the radio will emit the Resume Scan Beep.

6 BATTERY ACCESS DOOR (CASE BOTTOM)

The battery access door may be removed to access the battery pack. Refer to Battery Access & Installation, FIG-4, page 8.

7 JACK COVER

This rubber cover seals out dust and moisture, etc. Snap the cover into the audio accessory jack and charge jack openings when the jacks are not in use.

8 AUDIO ACCESSORY JACK

The audio accessory jack is used to plug in earphone options, and, in conjunction with the charge jack, to connect an optional remote speaker/ microphone or a single- or dual-ear headset. This jack is also used for PC programming.

9 CHARGE JACK

The battery pack may be charged through this jack using the supplied RITRON charger cube. Refer to Accessories, page 1, for additional charging options.

10 SPEAKER

The speaker, located behind the front grille, allows you to hear calls on your channel.

11 MICROPHONE

The microphone allows your voice to be heard in transmissions to other radios. Speak in a normal tone; shouting does not improve your listener's reception.

12 DROP-IN CHARGING CAPABILITY

Two contacts, in the bottom of the radio, permit charging the battery pack with an optional drop-in charger. Refer to Optional Charging Accessories, page 8.

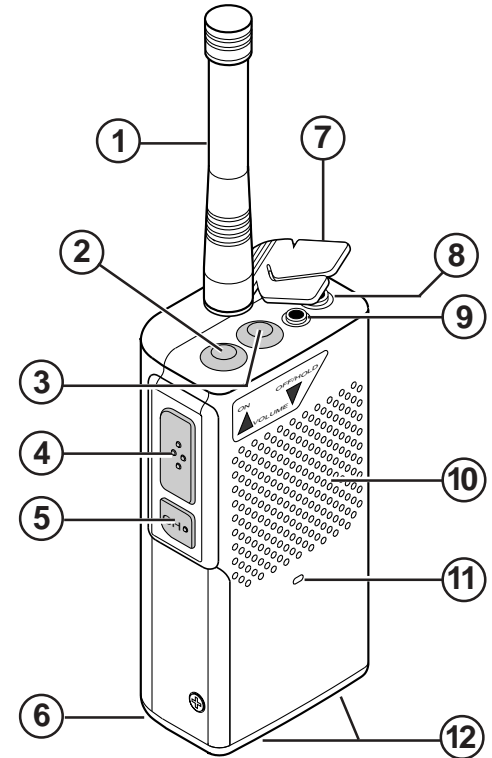

FIG-2: RADIO CONTROLS & CONNECTORS

IMPORTANT: CHARGE THE BATTERY PACK before using the radio for the first time. Refer to Batteries, pages 8 and 9

www.TwoWayRadioEquipment.com | (800) 878-7829 | Sales@TwoWayRadioEquipment.com

OPERATION

ON-OFF/VOLUME

To switch on the radio - press the On/Volume Up button. The radio will beep a number of times equal to the current channel number. If the radio turns on to the Scan Channel it will emit the Resume Scan Beep.

To adjust the volume - press the volume up button until you reach the desired level. You should hear noise and any broadcasts on the channel.

To turn off the radio - press and hold the Off/Volume Down button until two tones sound.

To determine whether the radio is on - press the volume down button. If the radio is on, noise or activity on the channel is heard.

CHANNEL SELECTION

To change channels - press and release the Channel button. The radio will beep a number of times equal to the current channel number. Pressing the Channel button again within 3 seconds will increment the channel and the radio will beep the new channel number.

Example: If you select channel 2, the handheld will beep twice.

If the highest channel number is selected and you press the Channel button, the radio resets to channel 1.

A one-channel radio will beep only once when you press the Channel button.

If the Scan Channel is selected The radio will emit the Resume Scan Beep.

RECEIVE

To hear calls from other users - adjust the volume as desired. The radio can receive broadcasts while the Push-To-Talk button is not being pressed. Whether or not you hear these broadcasts depends upon the squelch settings.

There are two types of squelch used in the SST "Four Series" portable. First is carrier squelch. This lets you hear all broadcasts on your channel strong enough for the radio to detect, and silences noise. Second is one of the selective signaling or "tone squelch" formats available on the SST. This allows you to screen out "on-channel" broadcasts that do not carry the correct code programmed for the radio.

Note: It is possible that the beginning of a call might be missed while the radio is in battery saver mode. If this happens, ask the caller to repeat the message.

SELECTIVE SIGNALING SQUELCH

To activate tone squelch - simultaneously press both of the volume buttons. Hold for a second or two before releasing. When tone squelch is turned on, the handheld sounds one beep. When carrier squelch is on, the radio emits a "double beep."

Note: If you continue to hold down the volume buttons after the beep (or double beep), the radio will start beeping repeatedly. This means that squelch is turned off. Release the buttons. To restore squelch, press and hold both of the volume buttons until the radio sounds a beep or double beep.

MONITOR

To monitor the channel - press one of the volume control buttons. When you press the volume up or the volume down button, squelch turns off and all radio traffic on the channel (and noise) sounds in the speaker.

QUIET CALL TONE CODES (Interference Eliminator Codes)

Tone codes filter out static, noise and reduce unwanted "chatter" on radio channels. When you operate on a frequency with a tone code, you screen out most interference. This allows you to communicate with less interference and to hear only those users in your radio group.

IMPORTANT! All radios in the talk group must operate on the same frequency and tone code.

TRANSMIT

Normally, you should not transmit until no one is talking on the channel.

To transmit - hold down the Push-To-Talk button and with the radio four inches away talk into the microphone. Speak in a normal tone, since talking louder will not improve the listener's reception.

OPERATION

RADIO ALERT TONES

The handheld responds to certain instructions by sounding a beep or series of tones. These tones can tell you whether the radio is working as you expect.

Power On/Self Check “OK”

When it is first turned on, the radio runs a quick “self test” to confirm basic functions. The radio then beeps the number of times equal to the channel number selected. The radio is then ready to use.

Error Tones

However, if the “self test” detects a diagnostic error, an error tone sounds. Alternating tones (the second is longer and lower pitched) indicate the radio frequency synthesizer is malfunctioning. Turn off the radio and try again. A long, low-pitched tone means the battery voltage is too low to operate the radio. In this case, recharge the battery. If you cannot correct a problem, consult an authorized Ritron service facility or Ritron.

Channel Select

When the Channel button is pressed, the radio beeps a number of times equal to the current channel number. Pressing the Channel button again will increment the channel and the radio will beep the new channel number.

Recharge Battery Alert

As the battery voltage approaches the minimum required “operating voltage” the radio will emit a short beep every 20 seconds to alert the user that the battery will soon need recharging. Once the battery charge drops below the required “operating voltage,” the radio emits a long, low tone and turns itself off. If you turn the radio back on, it will beep again and shut itself off. Recharge the battery.

Tone Squelch

When you press and hold both Volume buttons at the same time, a single beep will sound to indicate that tone squelch is on. A “double beep” means that carrier squelch is on.

OPTIONAL ALERT TONES

The SST “Four Series” radio can be programmed using the RITRON PC Programmer for optional alert tones.

Receive Squelch Tone

A short tone sounds at the end of each received transmission to indicate that you may transmit.

Busy Channel TX Inhibit

If a user is transmitting on your radio frequency without your tone, you will not be allowed to transmit. The radio will beep a series of long, low tones while the PTT is held down (like a busy signal).

Transmitter Time Out

A low tone followed by a higher-pitched tone sounds and the transmitter automatically shuts off if you hold down the PTT button longer than the programmed Time-out. The radio automatically switches to receive mode. Authorized service personnel can turn off this feature.

Transmit Clear To Talk Beep

A short tone sounds after the PTT has been released to indicate that you have stopped transmitting.

WEATHER SCAN (VHF RADIOS ONLY)

TO SCAN STANDARD U.S. WEATHER FREQUENCIES and hear weather forecasts, follow the steps in FIG-3 below. To resume normal two-way operation, turn the radio off, then on again.

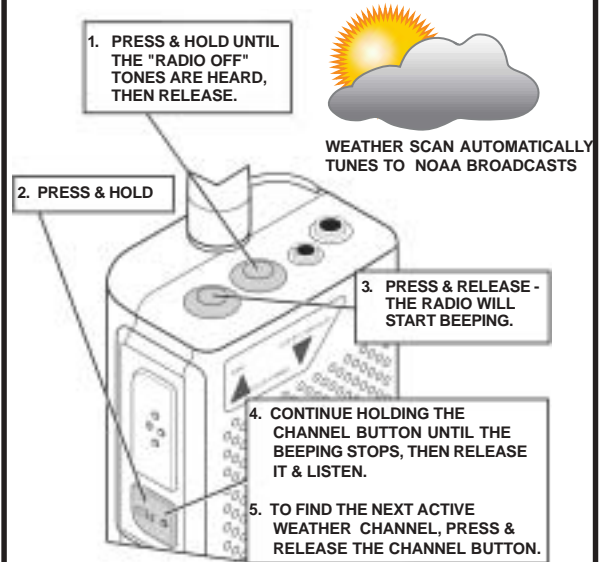

FIG-3: TO SCAN WEATHER FREQUENCIES

CHANNEL SCAN OPERATION

Channel scanning allows you to listen to broadcasts on many different radio channels. To **utilize this feature the radio must be PC programmed by your dealer with a Scan Channel containing a list of the channels to be scanned.**

How Scanning Works

Using the Channel Select button, select the Scan Channel. The radio pauses, sounds a **Resume Scan Beep**, and then repeatedly checks each channel of the scan list in the order they were programmed into the list.

When receiving a call on a channel being scanned, the radio will stop scanning to let you hear communications on that channel. After the transmission has ended the radio will pause before it resumes scanning to allow you time to respond. The **Resume Scan Beep** will sound when the radio resumes scanning.

When transmitting from the Scan Channel, the handheld will go to the last channel on which a signal was received and transmit. After you release the PTT the radio will pause to allow time for a response, sound the **Resume Scan Beep**, and resume scanning.

Priority Scanning

The priority scan option allows you to periodically monitor a Priority Channel, even if the radio has stopped on another channel. With Priority Scan enabled, the first channel in the scan list is the Priority Channel. The radio can also be programmed to transmit only on the Priority Channel when scanning, if desired. The SST "Four Series" handheld can also be programmed to sound a Priority Channel Beep whenever the radio receives on the Priority Channel when scanning.

Nuisance Channel Delete

If one of the channels in the scan list is so busy that you want to temporarily delete it from the list, **press and hold the channel button** until the **Resume Scan Beep** sounds. Scanning will resume indicating the channel has been deleted. **(NOTE: The first channel in the scan list cannot be deleted).** The deleted channel will now be skipped in the scan list. The deleted channel will be returned to the scan list if the radio is turned off, or when the radio channel is changed using the Channel Select button.

Last Channel Scanned Alert Tone

When changing channels with the Channel Select button, an alert tone will sound immediately after the channel number beeps to indicate the last channel that received a message when the radio was scanning. This will identify the channel on which the last message was received, and allow uninterrupted transmission on that channel without the constraints of scanning. You can then press the Channel Select button to return to the scan channel.

RADIO PROGRAMMING

The SST "Four Series" radio is PC programmed using software developed by Ritron, Inc. All programming and alignment of the SST "Four Series" radio must be performed by a licensed radio service technician. Consult your Ritron dealer for re-programming of your radio, or contact Ritron at 800-872-1872 for referral to an authorized Ritron dealer.

Use the following chart to log your SST "Four Series" radios programming:

CHANNEL	RECEIVE FREQUENCY	TRANSMIT FREQUENCY	RECEIVE TONE CODE	INVERT	TRANSMIT TONE CODE	INVERT	TRANSMIT POWER (HL)	TRANSMIT BANDWIDTH (W/V)
1	_____ MHz	_____ MHz	_____	<input type="checkbox"/>	_____	<input type="checkbox"/>	_____	_____
2	_____ MHz	_____ MHz	_____	<input type="checkbox"/>	_____	<input type="checkbox"/>	_____	_____
3	_____ MHz	_____ MHz	_____	<input type="checkbox"/>	_____	<input type="checkbox"/>	_____	_____
4	_____ MHz	_____ MHz	_____	<input type="checkbox"/>	_____	<input type="checkbox"/>	_____	_____
5	_____ MHz	_____ MHz	_____	<input type="checkbox"/>	_____	<input type="checkbox"/>	_____	_____
6	_____ MHz	_____ MHz	_____	<input type="checkbox"/>	_____	<input type="checkbox"/>	_____	_____
7	_____ MHz	_____ MHz	_____	<input type="checkbox"/>	_____	<input type="checkbox"/>	_____	_____
8	_____ MHz	_____ MHz	_____	<input type="checkbox"/>	_____	<input type="checkbox"/>	_____	_____
9	_____ MHz	_____ MHz	_____	<input type="checkbox"/>	_____	<input type="checkbox"/>	_____	_____
10	_____ MHz	_____ MHz	_____	<input type="checkbox"/>	_____	<input type="checkbox"/>	_____	_____

SCAN LIST

(Enter the Channel numbers from the Chart above)

- | | | |
|---|----------------|---------|
| 1 | Priority _____ | |
| 2 | _____ | 6 _____ |
| 3 | _____ | 7 _____ |
| 4 | _____ | 8 _____ |
| 5 | _____ | 9 _____ |

INTERFERENCE ELIMINATOR TONE CODES

TABLE 1: PROGRAMMABLE QC (QUIET CALL) TONE CODES

QUIET-CALL CODE	Freq. (Hz)	Other Radio Brands Tone Code	QUIET-CALL CODE	Freq. (Hz)	Other Radio Brands Tone Code
01	67.0	XZ	27	167.9	6Z
02	71.9	XA	28	173.8	6A
03	74.4	WA	29	179.9	6B
04	77.0	XB	30	186.2	7Z
05	79.7	SP	31	192.8	7A
06	82.5	YZ	32	203.5	M1
07	85.4	YA	33	210.7	--
08	88.5	YB	34	218.1	--
09	91.5	ZZ	35	225.7	--
10	94.8	ZA	36	233.6	--
11	97.4	ZB	37	241.8	--
12	100.0	1Z	38	250.3	--
13	103.5	1A	39	69.4	--
14	107.2	1B	40	159.8	--
15	110.9	2Z	41	165.5	--
16	114.8	2A	42	171.3	--
17	118.8	2B	43	177.3	--
18	123.0	3Z	44	No Tone	--
19	127.3	3A	45	183.5	--
20	131.8	3B	46	189.9	--
21	136.5	4Z	47	196.6	--
22	141.3	4A	48	199.5	--
23	146.2	4B	49	206.5	--
24	151.4	5Z	50	229.1	--
25	156.7	5A	51	254.1	--
26	162.2	5B			

TABLE 2: PROGRAMMABLE DQC (DIGITAL QUIET CALL) TONE CODES

DIGITAL QUIET-CALL CODE	INVERT OF THE CODE	DIGITAL QUIET-CALL CODE	INVERT OF THE CODE	DIGITAL QUIET-CALL CODE	INVERT OF THE CODE	DIGITAL QUIET-CALL CODE	INVERT OF THE CODE
023	047	143	412	315	423	532	343
025	244	152	115	331	465	546	132
026	464	155	731	343	532	565	103
031	627	156	265	346	612	606	631
032	051	162	503	351	243	612	346
043	445	165	251	364	131	624	632
047	023	172	---	365	125	627	031
051	032	174	074	371	734	631	606
054	413	205	263	411	226	632	624
065	271	223	134	412	143	654	743
071	306	226	411	413	054	662	466
072	245	243	351	423	315	664	311
073	506	244	025	431	723	703	565
074	174	245	072	432	516	712	114
114	712	251	165	445	043	723	431
115	152	261	732	464	026	731	155
116	754	263	205	465	331	732	261
125	365	265	156	466	662	734	371
131	364	271	065	503	162	743	654
132	546	306	071	506	073	754	116
134	223	311	664	516	432		

!! CAUTIONS — ALL RADIOS !!

OBSERVE CAUTION IN THE FOLLOWING ENVIRONMENTS TO MAXIMIZE THE LIFE OF YOUR RADIO EQUIPMENT:

MOISTURE: SST Series radios are not waterproof. DO NOT directly expose them to rain or excessive moisture.

CHEMICALS: Detergents, alcohol, aerosol sprays or petroleum products can damage the radio case. DO NOT use petroleum solvents of any kind; use a soft cloth moistened with water to clean the case.

EXTREME HEAT: High temperatures can damage the battery and other components. DO NOT expose the units to extreme heat or leave them in direct sunlight.

LOW TEMPERATURES: The capacity of the NiCd battery is greatly reduced in extreme cold. When using the unit in very cold environments, periodically warm the radio under your coat.

EXCESSIVE TRANSMISSIONS: Maximum drain on battery power occurs when you are transmitting. DO NOT hold the Push-To-Talk switch down longer than necessary during transmission intervals. DO NOT reduce battery service life by attempting to power a radio with a depleted battery; always charge batteries overnight after each day of use.

VIBRATION/ SHOCK: Although your SST Series radio is designed to be rugged, it will not survive excessive abuse. Avoid dropping the radio.

NOTE: The optional MH-A holster provides added protection from weather and shock.

EXPOSURE TO RADIO FREQUENCY ENERGY

The JMX/SST Series handheld radios generate RF electromagnetic energy during transmit mode. The transmit mode is active when the PTT switch is depressed. This radio is designed for, and classified as, "Occupational Use Only", meaning that it must be used only during the course of employment by individuals who are aware of the hazards and the ways to minimize such hazards. This series of radios is NOT intended for use by the "General Population" in an uncontrolled environment.

When used as directed, this series of radios is designed to comply with the FCC's RF exposure limits for "Occupational Use Only". In addition, they are designed to comply with the following Standards and Guidelines:

- FCC OET Bulletin 65, Edition 97-01, Supplement C, Evaluating Compliance with FCC Guidelines for Human Exposure to Radio Frequency Electromagnetic Fields.
- American National Standards Institute (C95.1-1992), IEEE Standard for Safety Levels with Respect to Human Exposure to Radio Frequency Electromagnetic Fields, 3 kHz to 300 GHz.
- American National Standards Institute (C95.3-1992), IEEE Recommended Practice for the Measurement of Potentially Hazardous Electromagnetic Fields-RF and Microwave.

To ensure that exposure to RF electromagnetic energy is within the FCC allowable limits for occupational use, always adhere to the following guidelines:

- Use only the antenna(s) available from RITRON for these models. **DO NOT** attempt to substitute any other antenna. **DO NOT** operate the radio without an antenna.
- Keep talk times as short and infrequent as possible. **DO NOT** depress the PTT button when not actually wishing to transmit. These radios are equipped with an internal timer to limit continuous transmit times. **DO NOT** exceed a 50% transmit duty cycle.
- When transmitting, hold the radio in front of the mouth at a distance of at least 4 inches. **DO NOT** hold the radio in such a manner that the antenna is next to, or touching, exposed parts of the body, especially the face or eyes while transmitting.
- In belt mounted applications, when transmitting, remove the radio from the belt and hold away from the body at least 4 inches.
- When using external headset accessories, hold the unit away from the body at least 4 inches while transmitting.
- **DO NOT** allow children to operate the radio.

BATTERIES

FIG-4: BATTERY ACCESS & INSTALLATION:

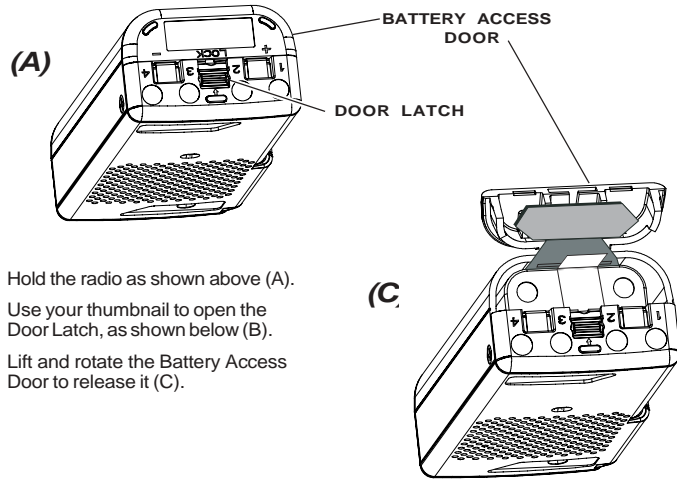

1. Hold the radio as shown above (A).
2. Use your thumbnail to open the Door Latch, as shown below (B).
3. Lift and rotate the Battery Access Door to release it (C).

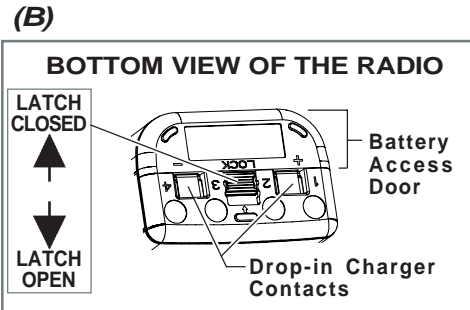

4. Use the Pull-tab to pull the battery pack out of the case (D).
5. Insert the replacement battery pack, being certain to POSITION IT RELATIVE TO THE CASE AS SHOWN IN (D). Push the Battery Pack in as far as possible.
6. Replace the Battery Access Door. Secure it by closing the Door Latch as shown in (B).
7. Be certain to firmly lock the Door Latch, as shown in (B).

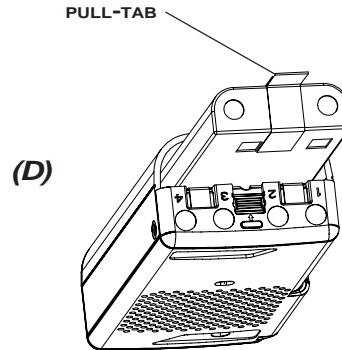

OPTIONAL CHARGING ACCESSORIES:

Spare/ Replacement
Battery Pack



Drop-in Battery Charger
with spacer

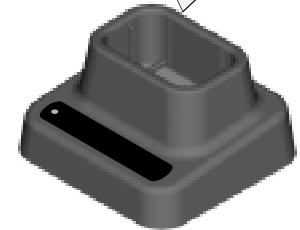
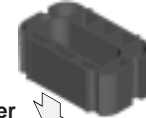

PATRIOT SST Accessories:

BPS-6N-SC	800 mAh Spare Battery Pack
BPS-6N-MH	1500 mAh Spare Battery Pack
BCPS-AD	Drop-in Charger Adapter
BCC-PS	Drop-in Charger/ Conditioner

See Accessories on page ii.

BATTERIES

CAUTION: Use only RITRON-supplied chargers; using other chargers may cause fire or explosion, or otherwise damage the radio.

GENERAL

The SST Series radio is powered by a rechargeable battery pack.

CHARGING

Because the battery pack loses its charge during storage and shipment, fully charge it before first use. To ensure peak radio performance for the next day, charge the battery overnight after each day of use. It completely charges in about ten hours.

TO CHARGE THE BATTERY WITH A RITRON CUBE CHARGER

Plug the charger cord into the charge jack (marked "CHG") on top of the radio. Then plug the cube into an 110 VAC outlet. The green lamp lights while the battery is charging, and should go out only when the cube or cord is unplugged.

TO CHARGE THE BATTERY WITH A RITRON DROP-IN CHARGER

Two charger contacts, visible through the radio case bottom, permit charging the battery with an optional Ritron drop-in charger. The battery pack may be either removed from the radio case for charging, or charged inside the radio case.

Each drop-in charger comes with a spacer to permit charging a "spare" battery while the radio is being used.

To use the drop-in charger, plug it into a 110 VAC outlet. Set either the radio with the battery installed, or only the battery with the battery spacer, into the charger. Refer to the illustration in Optional Accessories, opposite. Each battery contact must rest on a charger contact pin.

NOTE:

Battery pack life averages one year. Follow these guidelines to maximize service life:

- CONDITION battery packs once a month as directed in Battery Maintenance & Conditioning, at right.
- CONDITION batteries that are run down.
- CHARGE batteries for 16 hours before storage, and for 16 hours once a month thereafter.
- DO NOT overcharge batteries. Unplug the cube charger after 16 hours to avoid overcharging.
- DO NOT charge batteries in temperatures colder than about 45°F. Charging batteries in temperatures above 95°C. does not harm them, but can reduce charge capacity.

BATTERY MAINTENANCE & CONDITIONING

Due to the extended run time of the SST Series radios, some users may never fully discharge the NiCad battery pack during normal use. Achieve maximum battery life by fully discharging the battery periodically to condition it.

After exposing the battery pack to many cycles of not fully discharging it before recharging, the radio may exhibit reduced battery capacity. This reduced capacity is evident when, after several hours of use, battery voltage drops while the radio is transmitting, causing the radio to emit a dead battery warning tone and shut itself off.

Condition battery packs by the following procedure as either a preventive measure, or if you suspect reduced capacity:

TO CONDITION THE BATTERY PACK:

1. Use your radio throughout a normal work day without charging.
2. • Press and hold the On/ Volume Up and Volume Down/ Off buttons simultaneously for 8 seconds to place the radio in "open squelch" mode.
 - Release both buttons when you hear the radio beep rapidly; it will then emit a loud "rushing" noise. Press On/ Volume Up to maximize this noise.
3. • Put the radio away in a secure place (possibly a desk drawer), where nothing can press against the buttons to accidentally turn it off or cause it to transmit. Allow the radio to run until it shuts off when the battery is completely discharged. A typical battery pack may require about 8 hours to completely discharge.
4. • When the radio has shut off, charge it overnight for 12-14 hours. The battery will be ready for use with renewed capacity.

NOTE: A new battery must be charged and discharged several times before it can reach its maximum charge capacity.

TROUBLESHOOTING

NOTES

1. • Try a battery pack from a working radio. If the radio in question works with that pack, the original battery is suspect.
 - Charge the suspect battery as recommended in this manual. If this original battery cannot power the radio, try charging it again with another charger. If the battery still doesn't hold a charge, the pack should probably be replaced.
 - If the battery appears to be "good" after using the second charger, the first charger may be faulty. Contact a dealer or Ritron about an accessory that is not operating properly.
2. • Reception can often be improved if you relocate by a short distance. This effect is more noticeable inside buildings.
 - The range for SST radios is about two miles, line-of-sight.
3. If your radio does not detect calls from other radios on the channel, turn off Quiet Call by pressing and holding both volume buttons at the same time—a double beep indicates Quiet Call is off.
4. • Without use of a repeater: To hear a call, select a channel programmed to receive the caller's transmit frequency. To call another unit, select a channel programmed to transmit the other radio's receive frequency.
 - Using a repeater: A radio channel can hold two separate operating frequencies, one for receive and one for transmit. Your channel must work with the repeater's transmit and receive frequencies.
5. • Maximum power drain occurs when the radio transmits, so don't hold down the PTT more than needed to transmit.
 - Battery power is used while the handheld is left on to receive calls. If practical, switch off the unit.
6. • Battery capacity is greatly reduced in extreme cold.
 - To use the radio in very cold weather, periodically warm it under your coat if possible.
 - An optional remote speaker/microphone allows keeping the radio under your coat while transmitting and receiving.
7. • To "talk" with each other, radios must be programmed identically for Quiet Call code, as well as frequency. Each code is unique; radios respond only to the code programmed.
 - Press and hold both volume buttons at the same time. A single beep indicates Quiet Call squelch is on. A double beep indicates Quiet Call squelch is off.

CHART

If you have trouble operating the handheld, review the Control & Operation, pages 2 and 3. If you think the radio is malfunctioning, check the list below.

Problem	Possible Solutions
GENERAL	
The radio does not work at all.	<ul style="list-style-type: none"> • Make sure that the battery is installed correctly, as shown in FIG-4. page 8. • Recharge or replace the battery. (See pages 8 & 9.)
Operating features do not work exactly as expected.	<ul style="list-style-type: none"> • The radio has been dealer programmed for customized operation. (Consult dealer.)
Reception is poor.	<ul style="list-style-type: none"> • Move to a different location. (See Note 2.) • Confirm the proper antenna is connected to the radio. (See page 2, Antenna)
You cannot hear calls from other radios.	<ul style="list-style-type: none"> • Turn off Quiet Call (coded) squelch. (See Note 3.) • Ensure radio receives on the same frequency as the caller transmits. (See Note 4.) • Recharge the battery. (See Note 1.)
Your calls cannot be heard in other radios.	<ul style="list-style-type: none"> • Make sure that your radio transmits on the receive frequency of the radio(s) you want to call. (See Note 4.) • Recharge the battery.
BATTERY	
Battery loses charge sooner than expected.	<ul style="list-style-type: none"> • Review battery charging instructions, page 9. • Conserve the battery. (See Note 5.) • If the radio is used in extreme cold, warm the radio under your coat. (See Note 6.) • Replace the battery; see FIG-4, page 8. (See Note 1.)
ERROR TONES	
An error tone sounds when the radio is first switched on.	<ul style="list-style-type: none"> • See "Error Tones" on page 4.
An error tone occurs while transmitting.	<ul style="list-style-type: none"> • Refer to "Transmitter Time-Out," page 4.
QUIETCALL	
You cannot screen out calls from users outside of your Quiet Call group.	<ul style="list-style-type: none"> • Make sure that the channel is programmed with Quiet Call. • Activate coded squelch. (See Note 7.)
You cannot hear Quiet Call messages while in Quiet Call (coded) squelch.	<ul style="list-style-type: none"> • Confirm that the channel is programmed to detect the same code as the calling radio(s) transmits. (See Note 7.)
Others in your Quiet Call group cannot hear your Quiet Call messages.	<ul style="list-style-type: none"> • Verify that you transmit the same code as the radio(s) you call are programmed to detect. (See Note 7.)

FCC LICENSE REQUIRED

FCC REGULATIONS

LICENSING —

The FCC requires the owners of the radios to obtain a station license before using them.

The station licensee is responsible for ensuring that transmitter power, frequency and deviation are within the limits specified by the station license. The station licensee is also responsible for proper operation and maintenance of the radio equipment. This includes checking the transmitter frequency and deviation periodically, using appropriate methods.

To get a FCC license for VHF or UHF frequencies, submit FCC application Form 600 as indicated in the block at right. Your Ritron dealer can help you with this process.

SAFETY STANDARDS —

The FCC (with its action in General Docket 79-144, March 13, 1985) has adopted a safety standard for human exposure to radio frequency electromagnetic energy emitted by FCC regulated equipment. Ritron observes these guidelines and recommends that you do also:

- DO NOT hold the radio so that the antenna is very close to or touching exposed parts of the body, especially the face or eyes, while transmitting. Keep the radio vertical, four inches away while talking into the front panel.
- DO NOT press the Push-To-Talk except when you intend to transmit.
- DO NOT operate radio equipment near electrical blasting caps or in an explosive atmosphere.
- DO NOT allow children to play with any radio equipment that contains a transmitting device.
- Repair of Ritron products should be performed only by Ritron authorized personnel.

SERVICE

Federal law prohibits you from making any internal adjustments to the transmitter, and/ or from changing transmit frequencies unless you are specifically designated by the licensee.

If your radio equipment fails to operate properly, or you wish to have the radio programmed, contact your authorized dealer or Ritron.

HOW TO OBTAIN AN FCC RADIO LICENSE

Federal Communications Commission (FCC) Licensing Information

Because your Ritron radio operates on Private Land Mobile frequencies, it is subject to the Rules and Regulations of the FCC, which requires all operators of these frequencies to obtain a station license before operating their equipment. Make application for your FCC license on FCC Forms 600 and 159.

*To have forms and instructions faxed to you by the FCC, call the **FCC Fax-On-Demand** system at **202-418-0177** from your fax machine; request Document 000600 & Form 159.*

*To have Document 000600 & Form 159 mailed to you, call the **FCC Forms Hotline** at **800-418-FORM** (800-418-3676).*

*For help with questions concerning the license application, contact the FCC at **888-CALL-FCC** (888-225-5322).*

*You must decide which radio frequency(ies) you can operate on before filling out your application; refer to Table 1 on page 5 of this manual. For help determining your frequencies, call Ritron at **800-USA-1-USA** (800-872-1872).*

RITRON, INC. LIMITED WARRANTY

WHAT THIS WARRANTY COVERS

RITRON, INC. ("RITRON") provides the following warranty against defects in materials and/or workmanship in **RITRON Radios, Rechargeable Batteries and Accessories** under normal use and service during the applicable warranty period (as stated below). "Accessories" means antennas, holsters, chargers, earphones, speaker/microphones and items contained in the programming and programming/service kits. Rechargeable batteries will be replaced during the applicable warranty period only if leakage occurs or the batteries drop below 75% of rated capacity.

WHAT IS COVERED	FOR HOW LONG	WHAT RITRON WILL DO
Portable SST Radios	1 year *	During the first year after date of purchase, Series RITRON will repair or replace the defective product, at RITRON's option, parts and labor included at no charge.
RITRON Rechargeable Batteries	1 year *	RITRON will replace the defective battery
Accessories	90 days *	* <i>After date of purchase</i>

WHAT THIS WARRANTY DOES NOT COVER:

- Any technical information provided with the covered product or any other RITRON products;
- Installation, maintenance or service of the product, unless this is covered by a separate written agreement with RITRON;
- Any products not furnished by RITRON which are attached or used with the covered product, or defects or damage from the use of the covered product with equipment that is not covered (such as defects or damage from the charging or use of batteries other than with covered product);
- Defects or damage, including broken antennas, resulting from:
 - misuse, abuse, improper maintenance, alteration, modification, neglect, accident or act of God,
 - the use of covered products other than in normal and customary manner or,
 - improper testing or installation;
- Defects or damages from unauthorized disassembly, repair or modification, or where unauthorized disassembly, repair or modification prevents inspection and testing necessary to validate warranty claims;
- Defects or damages in which the serial number has been removed, altered or defaced.
- Batteries if any of the seals are not intact.

IMPORTANT: This warranty sets forth the full extent of RITRON's express responsibilities regarding the covered products, and is given in lieu of all other express warranties. What RITRON has agreed to do above is your sole and exclusive remedy. No person is authorized to make any other warranty to you on behalf of RITRON. Warranties implied by state law, such as implied warranties of merchantability and fitness for a particular purpose, are limited to the duration of this limited warranty as it applies to the covered product. Incidental and consequential damages are not recoverable under this warranty (this includes loss of use or time, inconvenience, business interruption, commercial loss, lost profits or savings). **Some states do not allow the exclusion or limitation of incidental or consequential damages, or limitation on how long an implied warranty lasts, so the above limitations or exclusions may not apply to you. Because each covered product system is unique, RITRON disclaims liability for range, coverage, or operation of the system as a whole under this warranty.**

WHO IS COVERED BY THIS WARRANTY

This warranty is given only to the purchaser or lessee of covered products when acquired for use, not resale. This warranty is not assignable or transferable.

HOW TO GET WARRANTY SERVICE

To receive warranty service, you **MUST** deliver or send the defective product, delivery costs and insurance prepaid, within the applicable warranty period, to RITRON, INC., 505 West Carmel Drive, Carmel, Indiana 46032, Attention: Warranty Department.

Please point out the nature of the defect in as much detail as you can. **You MUST retain your sales or lease receipt (or other written evidence of the date of purchase) and deliver it along with the product.** If RITRON chooses to repair or replace a defective product, RITRON may replace the product or any part or component with reconditioned product, parts or components. Replacements are covered for the balance of the original applicable warranty period. All replaced covered products, parts or components become RITRON's property.

RIGHTS TO SOFTWARE RETAINED

Title and all rights or licenses to patents, copyrights, trademarks and trade secrets in any RITRON software contained in covered products are and shall remain in RITRON. RITRON nevertheless grants you a limited non-exclusive, transferable right to use the RITRON software only in conjunction with covered products. No other license or right to the RITRON software is granted or permitted.

YOUR RIGHTS UNDER STATE LAW

This warranty gives you specific legal rights, and you may also have other rights which vary from state to state.

WHERE THIS WARRANTY IS VALID

This warranty is valid only within the United States, the District of Columbia and Puerto Rico.

RITRON® *We Build Wireless Solutions*

Designed to work as an integrated system or as an add-on to virtually any existing two-way radio system



Quick Talk Alert for Remote Monitoring of any sensor or switch



Quick Talk OutPost XT
Ruggedized Two-Way Callbox



Quick Talk OutPost
Basic Two-Way Callbox



Quick Assist
Push-Button RF Transmitter

Battery-operated callboxes provide instant wireless communication over existing two-way radio systems

