

# PATRIOT®

## PATRIOT® SST DISPLAY SERIES OWNER'S MANUAL



### DISPLAY SERIES HANDHELDS COMPACT, ULTRA-SMALL PROFESSIONAL TWO-WAY RADIOS

- Up to 10 Channel Capability
- Easier Enhanced Programming Method
- 2, 3, and 4 Watt Models
- Quick-change Battery
- Drop-in Charge Capable
- Weather Channel Feature (VHF only) 
- Emergency Weather Alert Feature (VHF only)
- Channel Scan (Normal or Priority)
- Loud Easy-To-Hear High Audio Output
- Built-in Quiet Call® Interference Eliminator
- Digital Quiet Call® Interference Eliminator
- 2-Tone Paging Encode and Decode

**NOW**  
*with*  
**ENHANCED**  
Feature List

**MADE IN THE**  
**USA**

# ACCESSORIES



**RHD-1X**  
**Single Ear Headset**



**RHD-6X**  
**Behind-the-ear Earset**



**RHD-4X**  
**Dual Ear Headset**



**RHD-5X**  
**Over-the-ear Earset**



**RSM-3X**  
**Remote Speaker Mic**

## OPTIONAL ACCESSORIES:

### ***TO ORDER, CALL 800-USA-1-USA***

BPJS-6N ..... Spare/ Replacement JMX Battery  
 BPS-6N-SC ..... Spare/ Replacement SST Battery  
 BPS-6N-MH ..... Replacement High Capacity Battery

AFS-150 ..... VHF Molded Flex Antenna  
 AFS-450 ..... UHF Molded Flex Antenna

RHD-1X ..... Single Ear Headset  
 RHD-4X ..... Dual Ear Headset  
 RHD-5X ..... Lightweight Over-the-ear Earset /w In-line PTT  
 RHD-6X ..... Lightweight Behind-the-head Earset w/ In-line PTT

RSM-3X ..... Remote Speaker Microphone  
 REP-2 ..... Low Profile Earphone

CCL-B ..... Cigarette Lighter Charger

MHC-A ..... Cordura Holster w/beltclip & neckstrap

BCJS-4AD ..... 4-Well Drop-in Charger: JMX  
 BCPS-4AD ..... 4-Well Drop-in Charger: SST  
 BCPS-AD ..... Single-Well Drop-in Charger: SST (Overnight)  
 BCC-PS ..... Drop-in High-rate Charger/  
 Conditioner; for SST Models only  
 Call RITRON for complete listings.



**BCPS-AD**  
**Single-Well Drop-in Charger**



**BPS-6N-SC**  
**Spare Battery**



**BCPS-4AD**  
**4-Well Drop-in Charger**



**MHC-A**  
**Cordura Holster**

# TABLE OF CONTENTS

<u>DESCRIPTION</u>	<u>PAGE</u>
<b>ACCESSORIES</b>	
Optional Accessories .....	ii
<b>INTRODUCTION</b>	
SST "D-Series" Model Numbers .....	1
Features .....	1
<b>CONTROL &amp; OPERATION</b> .....	
FIG-1: Radio Controls and Connectors .....	2
<b>OPERATION</b>	
On-off/ Volume Adjust .....	3
Selecting Channels .....	3
Receiving Calls .....	3
QC and DQC Tone Codes (Interference Eliminator Codes) .....	3
FIG-2: Setting Squelch Mode .....	4
FIG-3: Transmit / Busy Lamp .....	4
Making Calls (Transmit) .....	4
Radio Alert Tones .....	4
Optional Alert Tones .....	5
Scan Channel Operation .....	5
Receive 2-Tone Page .....	6
Send 2-Tone Page .....	6
FIG-4: Reset 2-Tone Paging .....	6
<b>NOTES</b> .....	7
<b>NOAA WEATHER RADIO</b>	
How to Preset Your Radio for Local NOAA Weather Broadcasts .....	8
FIG-5: Presetting Your Local NOAA Weather Broadcasts .....	8
FIG-6: NOAA Frequencies .....	8
NOAA Weather Channel .....	8
Weather Alert .....	8
<b>RADIO PROGRAMMING</b>	
FIG-7: How To Place the Radio in Program / Readout Mode .....	9
How to Readout the Radio Identification Code / Placing the radio in Programming Mode .....	9
Channel Scan: How to Turn "ON / OFF" .....	9
Weather Channel: How to Turn "ON / OFF" .....	10
Weather Alert: How to Turn "ON / OFF" .....	10
PC Programmable Features .....	10

<u>DESCRIPTION</u>	<u>PAGE</u>
<b>BATTERIES</b>	
FIG-8: Battery Access and Installation .....	11
Optional Charging Accessories .....	11
Charging .....	12
Battery Maintenance and Conditioning .....	12
<b>!! CAUTIONS — ALL RADIOS !!</b>	
Observe Caution in the Following Environments to Maximize the Life of Your Radio Equipment .....	13
Exposure to Radio Frequency Energy .....	13
<b>TROUBLESHOOTING</b>	
Notes .....	14
Chart .....	14
<b>FCC LICENSE REQUIRED</b>	
FCC Regulations .....	15
Service .....	15
How to Obtain an FCC Radio License .....	15
<b>LIMITED WARRANTY</b> .....	<b>INSIDE BACK COVER</b>
<b>RITRON WIRELESS SOLUTIONS</b> .....	<b>BACK COVER</b>

## **INSPECTION**

Make sure the package includes:

- SST "D-Series" radio
- Antenna
- Rechargeable battery pack (installed in radio)
- Belt clip
- Owner's Manual

Examine the equipment immediately after delivery and report any damage to your shipping company.

**NOTE:** Refer to pages ii and 11 for Accessory information

# INTRODUCTION

## THANK YOU FOR CHOOSING RITRON

Congratulations on your purchase of the SST "D-Series" radio. Your new radio is the culmination of Ritron's 25 years of designing, manufacturing, and supplying reliable, professional wireless communication products. Ritron wireless products will improve the operation, safety, and profitability of any organization by providing instant voice communications between employees throughout the workplace.

## SST "D-SERIES" MODEL NUMBERS

### VHF MODELS

**SST-144D** ..... (Patriot) ..... (4-Watt, 10 Channel)

### UHF MODELS

**SST-446D** ..... (Patriot) ..... (2-Watt, 10 Channel)

**SST-444D** ..... (Patriot) ..... (3-Watt, 10 Channel)

The model number located on the back of the radio case indicates its operating band.

VHF radios are designed to operate on up to ten channels within the 12 MHz band between factory standard 150 and 162 MHz.

UHF radios are designed to operate on up to ten channels within the 20 MHz band between factory standard 450 and 470 MHz.

## FEATURES

This manual covers the Ritron SST "D-Series" radios. These radios are compact, programmable two-way handhelds designed to operate in a professional FM communications band (VHF or UHF business available). Each radio is equipped with these features:

- **Push-button operating controls.** The Push-To-Talk (PTT) and Channel buttons are on one side of the radio, and the On/ Volume Up, Volume Down/ Off and monitor controls on the top.
- **Channel display.** The LED display will show the current operating channel, and contains a transmit/ busy lamp. The display also indicates paging decode status on radios programmed for 2-tone paging operation.
- **Quick-change battery pack and drop-in charger capabilities.** See Optional Charging Accessories on the page 11.
- **10-channel capability.** Up to 10 channels can be programmed to contain a unique set of operating frequencies and options.
- **QC (Quiet Call) and DQC (Digital Quiet Call) interference eliminator codes.** Each channel can be programmed from a list of 51 QC sub-audible codes or 83 DQC digital privacy codes.
- **2-tone paging decode.** Each channel can be programmed for 2-tone paging decode within a frequency range of 300-1500 Hz. Additional 2-tone paging features include Group Call, All Call, automatic reset, and transpond alert.
- **2-tone paging encode.** Each channel can be programmed for 2-tone paging encode within a frequency range of 300-1500 Hz.
- **Wide or narrow band operation.** Each channel is programmable for wide or narrow band transmit operation.
- **High or low transmit power.** Each channel can be programmed for high or low transmit power to satisfy your needs for extended range or battery conservation. (This option is not available on the SST-446D)
- **Channel scanning.** The Scan channel allows scanning of all channels programmed into the radio, and can be turned On and Off through Field programming. The scan channel has many features, including Priority Scanning and Busy Channel Blocking.
- **Weather Channel.** VHF models can be programmed to receive your local NOAA weather radio broadcast. The Weather channel can be turned On and Off through Field programming.
- **Weather Alert.** VHF models can be programmed to alert you when the National Weather Service detects threatening weather conditions. The Weather Alert feature can be turned On and Off through Field programming.
- **Low battery alert.** The SST "D-Series" radio will sound a series of low battery alert tones when your battery is running down to allow you time to recharge or change your battery.
- **Alert tones.** Each channel is programmable for a variety of alert tones that include RX courtesy beep, TX clear to talk beep, busy channel lockout alert, last active channel marker, and channel scanning indicator.
- **Squelch adjustment.** Squelch sensitivity can be programmed on a per channel basis to meet your specific needs.

# CONTROL & OPERATION

## 1 ANTENNA

The flexible antenna radiates and receives radio signals. Screw the antenna base all the way into the threaded bushing on top of the radio.

**NOTE:** Use only the type of antenna furnished with the radio. VHF and UHF antennas are not interchangeable.

## 2 ON/ VOLUME UP

To switch the unit On, press the On/Volume Up button; the speaker will emit a turn on beep. If the radio turns on to the Scan Channel it will emit the Resume Scan Beep. Once the radio is On, press this button to increase volume.

## 3 VOLUME DOWN/ OFF

Press the Volume Down/Off button to decrease volume. To switch Off the unit, press and hold this button until the speaker emits a double beep.

## 4 PUSH-TO-TALK SWITCH (PTT)

Press and hold the PTT when transmitting; release it to receive.

## 5 CHANNEL SELECTOR

Press the button and the radio will emit the channel beep, advance the channel, and the channel display will show the new operating channel. When the Scan Channel is selected the radio will emit the Resume Scan Beep and the radio will begin scanning.

## 6 BATTERY ACCESS DOOR (CASE BOTTOM)

The battery access door may be removed to access the battery pack. Refer to Battery Access & Installation, FIG-8, page 11.

## 7 JACK COVER

This rubber cover seals out dust and moisture, etc. Snap the cover into the audio accessory jack and charge jack openings when the jacks are not in use.

## 8 AUDIO ACCESSORY JACK

The audio accessory jack is used to plug in earphone options, and, in conjunction with the charge jack, to connect an optional remote speaker/ microphone or a single- or dual-ear headset. This jack is also used for PC programming.

## 9 CHARGE JACK

The battery pack may be charged through this jack using the RITRON charger cube. Refer to Accessories, page ii, for additional charging options.

## 10 CHANNEL DISPLAY

The channel display will indicate the current operating channel. When the Scan Channel is selected the display will rapidly flash the channels being scanned, and will stop when a channel is received.

## 11 SPEAKER

The speaker, located behind the front grille, allows you to hear calls on your channel.

## 12 MICROPHONE

The microphone allows your voice to be heard in transmissions to other radios. Speak in a normal tone; shouting does not improve your listener's reception.

## 13 DROP-IN CHARGING CAPABILITY

Two contacts, in the bottom of the radio, permit charging the battery pack with an optional drop-in charger. Refer to Optional Charging Accessories, page 11.

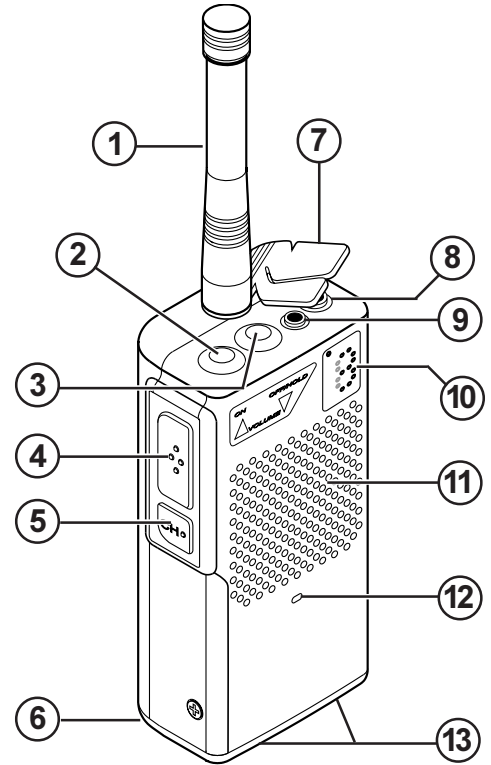

FIG-1: RADIO CONTROLS & CONNECTORS

**IMPORTANT:** CHARGE THE BATTERY PACK before using the radio for the first time. Refer to Batteries, pages 11 and 12.

# OPERATION

## ON-OFF / VOLUME ADJUST

To turn on the radio - press the On/Volume Up button. The radio will emit the Channel beep. If the radio turns on to the Scan Channel it will emit the Scan Beep. The radio will turn on to the channel that was selected when it was last turned off, or can be programmed to always turn on to channel 1.

To adjust the volume - press the volume up or the volume down button until you reach the desired level. You should hear noise or any broadcasts on the channel.

To turn off the radio - press and hold the Off/Volume Down button until a two tone "turn-off" beep is heard. For instant turn-off, press the PTT button while holding the Off/Volume Down button.

## SELECTING CHANNELS

To change channels - press and release the Channel Selector button. The radio will emit a short Channel beep, increment the channel, and the Channel Display will show the new operating channel. If the highest channel number is selected and you press the Channel Selector button, the radio resets to channel 1 and the Channel beep is heard on the speaker.

If the Scan Channel is selected - the radio will emit the Scan Beep and the Channel Display will rapidly flash the channel numbers as they are scanned. If a signal is received the channel display will indicate the channel number, and when the received signal is removed the radio will wait briefly, sound the Scan Beep, then scanning will resume as normal.

If the Weather Channel is selected - on a VHF radio the Channel beep will be heard and the display will light a single segment that indicates which of the seven NOAA frequencies is monitored. See the "NOAA Weather Radio" section on page 8 for details.

## RECEIVING CALLS

To hear calls from other users - adjust the volume as desired. The radio can receive broadcasts while the Push-To-Talk button is not being pressed. Whether or not you hear these broadcasts depends upon the squelch settings.

There are four squelch modes that can be used in the SST "D-Series" portable.

- **Carrier squelch** lets you hear all broadcasts on your channel strong enough for the radio to detect, and silences noise.
- **Tone squelch** uses one of the QC or DQC "tone squelch" formats available on the SST. This allows you to screen out "on-channel" broadcasts that do not carry the correct code programmed for the radio.
- **No squelch** disables all squelch operation and allows you to hear even the weakest broadcasts on your channel.
- **2-tone paging** can be used in conjunction with either carrier or tone squelch to block out all calls except those sent specifically to your radio. When the unique 2-tone sequence programmed into the radio is decoded, the radio will emit a series of ring tones similar to a telephone.

If Carrier or Tone Squelch has been selected by the user, all channels will operate in that mode. The SST "D-Series" radio will operate in tone squelch mode when it is 1st turned on.

To monitor the channel - press one of the volume control buttons. When you press the volume up or the volume down button, squelch turns off and all radio traffic on the channel (or noise) sounds in the speaker.

To activate carrier squelch - simultaneously press both of the volume buttons and hold briefly before releasing. When carrier squelch is on, the radio emits a "double beep." The radio will now let you hear all broadcasts on your channel.

To activate tone squelch - simultaneously press both of the volume buttons and hold briefly before releasing. When tone squelch is turned on, the handheld sounds one beep. You will only hear broadcasts that carry the same QC or DQC code programmed into your radio.

To activate no squelch - simultaneously press both of the volume buttons and continue to hold them down. About 3 seconds after the beep (or double beep), the radio will start beeping repeatedly. This means that squelch is turned off. Release the buttons. To restore squelch, press and hold both of the volume buttons until the radio sounds a beep or double beep.

If you are unable to activate carrier or no squelch the radio has been optionally programming for Monitor Lockout. See your Ritron dealer or contact Ritron directly to disable this option.

### QC AND DQC TONE CODES (Interference Eliminator Codes)

Tone codes filter out static, noise and reduce unwanted "chatter" on radio channels. When you operate on a frequency with a tone code, you screen out most interference. This allows you to communicate with less interference and to hear only those users in your radio group.

**IMPORTANT!** All radios in the talk group must operate on the same frequency and tone code.



# OPERATION

To activate 2-tone paging - simultaneously press both of the volume buttons and hold briefly before releasing. When 2-tone paging is turned on, the handheld sounds a "triple beep". You will only hear broadcasts that first send your two unique paging tone.

**Note:** It is possible that the beginning of a call might be missed while the radio is in battery saver mode. If this happens, ask the caller to repeat the message.

To change squelch mode simultaneously press both of the volume buttons.

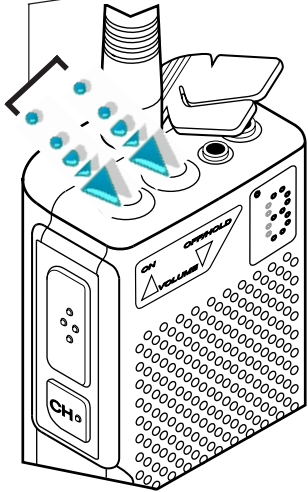
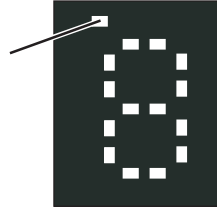

**FIG-2: SETTING SQUELCH MODE**

## MAKING CALLS (TRANSMIT)

Normally, you should not transmit until no one is talking on the channel. This can be determined by monitoring

A Transmit / Busy Lamp in the upper left corner of the Channel Display is lit whenever the transmitter is activated and blinks when the channel is busy.



**FIG-3: TRANSMIT/BUSY LAMP**

the channel prior to transmitting.

**To transmit** - hold down the Push-To-Talk button and with the radio four inches away talk into the microphone. Speak in a normal tone, since talking louder will not improve the listener's reception.

Keep talk times as short and infrequent as possible to conserve battery, minimize radio frequency exposure, and allow others to use the channel.

## RADIO ALERT TONES

The handheld responds to certain instructions by sounding a beep or series of tones. These tones can tell you that the radio is working as you expect.

### Power On/Self Check "OK"

When it is first turned on, the radio runs a quick "self test" to confirm basic functions. When complete the radio will emit the channel beep and the Channel Display will show the operating channel. The radio is then ready to use.

### Channel Scan Tone

When the Scan channel is selected by pressing the Channel button, the radio will emit the Scan beep and begin scanning.

## Squelch Mode Tones

When you press and hold both Volume buttons at the same time, a single beep will sound to indicate that tone squelch is on. A "double beep" means that carrier squelch is on. If the channel is programmed for 2-tone paging, a "triple beep" indicate that the pager has been reset.

## Transmitter Time Out Tone

A low tone followed by a higher-pitched tone sounds and the transmitter automatically shuts off if you hold down the PTT button longer than 60 seconds. The radio automatically switches to receive mode.

## Recharge Battery Alert Tone

As the battery voltage approaches the minimum required "operating voltage" the radio will emit a series of low battery tones to alert the user that the battery will soon need recharging. Once the battery charge drops below the required "operating voltage," the radio emits a long, low tone and turns itself off. If you turn the radio back on, it will beep again and shut itself off. Recharge the battery.

## Error Tones

If the "self test" detects a diagnostic error, an error tone sounds. The error tone indicates the radio frequency synthesizer is malfunctioning. Turn off the radio and try again. The error tone will also sound if a channel has been programmed for an invalid frequency. A long, low-pitched tone means the battery voltage is too low to operate the radio. In this case, recharge the battery. If you cannot correct a problem, consult an authorized Ritron service facility or Ritron.

# OPERATION

## OPTIONAL ALERT TONES

The SST "D-Series" radio can be programmed using the RITRON PC Programmer for optional alert tones. See your Ritron dealer or contact Ritron directly for programming of these options.

### Courtesy Beep

A short tone sounds at the end of each received transmission to indicate that the channel is clear and you may transmit.

### Busy Channel TX Inhibit Tone

If a user is transmitting on your radio frequency without your tone, you will not be allowed to transmit. The radio will beep a series of long, low tones while the PTT is held down (like a busy signal).

### Transmit Clear To Talk Beep

A short tone sounds after the PTT has been pressed to indicate that the radio is ready for you to begin talking.

## SCAN CHANNEL OPERATION

Channel scanning allows you to listen to broadcasts on your radio channels. The SST "D-Series" will scan all channels programmed into the radio except the NOAA Weather Channel.

### How Scanning Works

Using the Channel Selector button, select the Scan Channel. The radio sounds the Scan Beep, and then repeatedly checks each channel in the scan list. The channel display will show the channel numbers as they are scanned.

When receiving a call on a channel being scanned, the radio will stop scanning to let you hear communications on that channel. After the transmission has ended the radio will pause before it resumes scanning to allow you time to respond.

When transmitting from the Scan Channel, the handheld will go to the last channel on which a signal was received, then transmit. After you release the PTT the radio will pause to allow time for a response, and then resume scanning.

### Temporary Busy Channel Blocking

If one of the channels in the scan list is so busy that you want to temporarily block it out, press the Channel Selector button while the radio is stopped on the channel to be blocked and hold it until scanning resumes. The blocked channel will now be skipped in the scan list.

The blocked channel will be returned to the scan list if the radio is turned off, or when the radio channel is changed using the Channel Selector button. The 1st channel in the scan list cannot be blocked.

### Last Channel Scanned Alert Tone

When changing channels with the Channel Selector button, an alert tone will sound to indicate the last channel that received a message when the radio was scanning. This will identify the channel on which the last message was received, and allow uninterrupted transmission on that channel without the constraints of scanning. You can then press the Channel Selector button to return to the scan channel.

See "How to Turn Channel Scan On / Off" on page 9.

## Priority Scanning (Optional)

The SST "D-Series" radios can be optionally programmed for priority scanning. Priority Scan allows you to periodically monitor a Priority Channel, even if the radio has stopped on another channel. This will prevent missed calls on the primary operating channel when in scan mode.

With Priority Scan enabled:

- The first channel in the scan list is the Priority Channel.
- The radio checks the Priority Channel every two seconds to check for activity. This time is programmable and can be set for 1 - 8 seconds.
- The radio can be programmed to transmit only on the Priority Channel when scanning.
- The radio can be programmed to sound a Priority Channel Beep whenever the radio receives on the Priority Channel when scanning.

See your Ritron dealer or contact Ritron directly for PC programming of this option.



# OPERATION

## RECEIVE 2-TONE PAGE

To use 2-tone paging the SST "D-Series" radio must be PC programmed for this option, the radio does not operate with 2-tone decoding as it is received from the factory. See your Ritron dealer or contact Ritron directly for PC programming of this option.

To activate 2-tone paging you must first select a radio channel that has been PC programmed for 2-tone paging decode. The radio is normally programmed to automatically activate 2-tone decode any time the paging channel is selected. If not, simultaneously press both of the volume buttons and hold briefly before releasing. The handheld sounds three beeps when 2-tone paging is turned on. If you are unable to set the radio, you have selected a channel that is not programmed for 2-tone paging decode.

When receiving a 2-tone page the radio will emit a "ring" tone similar to a telephone and the display will show a "C" to indicate that a call has been received. You can now proceed with normal two way communication until 2-tone paging has been reset. The "ring" tone will sound every time a 2-tone page is decoded.



To reset 2-tone paging after receiving a call, simultaneously press both of the volume buttons and hold briefly before releasing. The handheld sounds three beeps when 2-tone paging is reset and the display will show the channel number. The radio can be optionally programmed to automatically reset if a call is not answered within 15 seconds.

2-tone paging channels can be optionally programmed to:

- Automatically set the radio for 2-tone paging mode whenever the channel is selected.
- Automatically reset if a 2-tone page is not answered within 15 seconds.
- Automatically place the receiver into carrier squelch "monitor" mode whenever a 2-tone page has been decoded.
- Transmit a transpond tone to let the paging station know that the page has been received.
- Decode an All Call tone.
- Decode a Group Call if the 1st tone is sent for an extended period of time.

## SEND 2-TONE PAGE

To use 2-tone paging the SST "D-Series" radio must be PC programmed for this option, the radio does not operate with 2-tone encoding as it is received from the factory. See your Ritron dealer or contact Ritron directly for PC programming of this option.

To send a 2-tone page you must first select a radio channel that has been PC programmed for 2-tone paging encode. Once the channel has been selected, press and hold the Channel button. After 2 seconds the radio will send the 2-tone page and the tones will be heard on the speaker. Release the Channel button and proceed with normal 2-way communications.

If you are unable to send a 2-tone page, you have selected a channel that is not programmed for 2-tone paging encode.

To reset 2-tone paging after receiving a call, simultaneously press both of the volume buttons and release. 2-Tone paging is reset when the radio sounds three beeps.

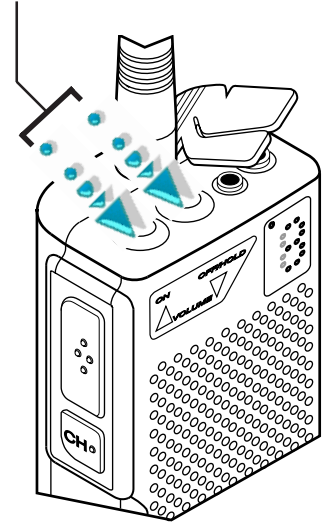

FIG-4: RESET 2-TONE PAGING



# NOAA WEATHER RADIO

## HOW TO PRESET YOUR RADIO FOR LOCAL NOAA WEATHER BROADCASTS

### (VHF MODELS ONLY)

VHF models of the SST "D-Series" radio can hear weather forecasts from the National Weather Service which are broadcast on **one of the seven** NOAA weather frequencies. *In some areas you may be able to receive more than one broadcast.*

The radio is shipped from the factory without a NOAA frequency selected. Before using any of the NOAA weather features on your VHF radio you must first select the local NOAA frequency.

1. Follow the steps in FIG-5 at right to place the radio into the Weather Frequency Select mode.
2. The radio will scan to the 1st NOAA frequency where a broadcast is present. The display will light a single segment to indicate the NOAA frequency per FIG-6.
3. Monitor the channel for a few minutes to be sure it is the broadcast for your local area.
4. Press the Channel button to scan for the presence of any other NOAA broadcasts, monitoring each broadcast and noting the frequency as indicated by the display.
5. Using the Channel button, select the local NOAA frequency you would like your radio to operate on.
6. Turn the radio off by pressing the Volume Down/Off button.
7. When the radio is turned back on all weather features will operate on the selected NOAA frequency.

NOTE: If you move to another location within your area, or to another state, you must "re-train" your radio with the local NOAA frequency.

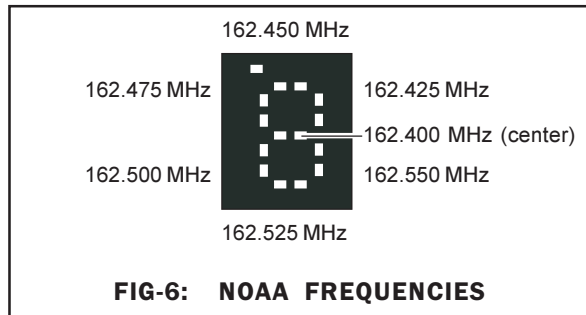
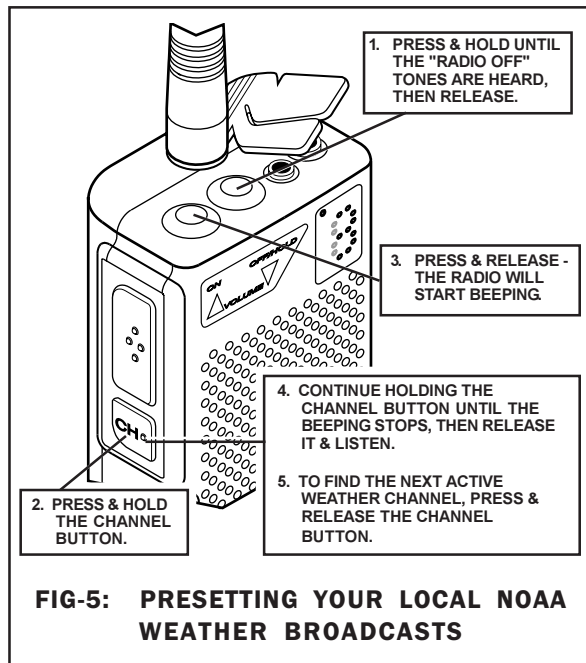

## NOAA WEATHER CHANNEL

Once a NOAA weather frequency has been selected on your VHF model radio, a channel is created for listening to National Weather Service broadcasts.

Press the Channel button to step through your radio channels. The NOAA Weather Channel will be after your last channel, and the display will light the segment representing the selected NOAA frequency.

If you do not desire a NOAA Weather Channel, it can be turned off through Field Programming.

See "How to Turn Weather Channel On / Off" on page 10.

## WEATHER ALERT

Once a NOAA weather frequency has been selected on your VHF model radio it will listen for emergency broadcasts from the National Weather Service, regardless of which channel you are on.

An alert tone will sound in the speaker, the display will show an "A" (as shown), and the National Weather Service emergency broadcast will be heard - advising you of threatening weather conditions. Pressing the Channel button will return you to your normal operating channel.



If you do not desire Weather Alert, it can be turned off through Field Programming.

See "How to Turn Weather Alert On / Off" on page 10.

# RADIO PROGRAMMING

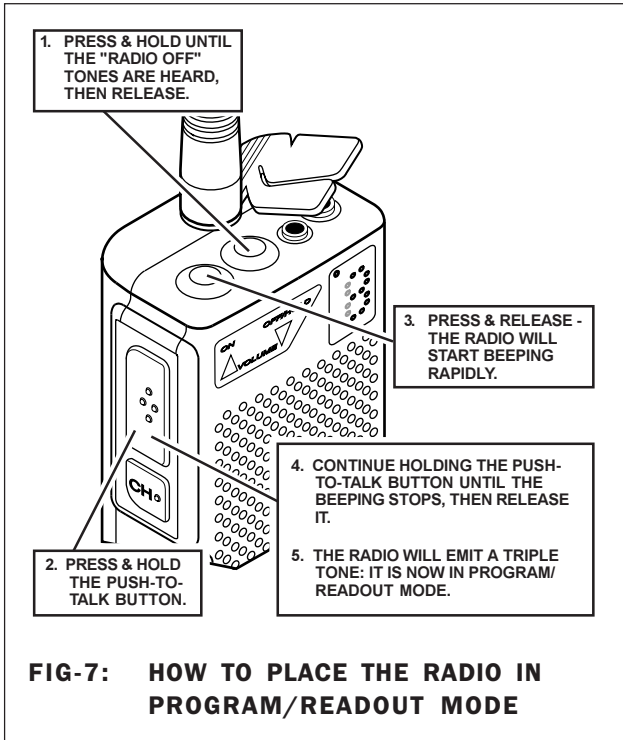

## HOW TO READOUT THE RADIO IDENTIFICATION CODE/ PLACING THE RADIO IN PROGRAMMING MODE.

In our example we will readout the Radio Identification of an SST-446D radio.

**RADIO IDENTIFICATION**

1. Place the radio into Program/ Readout Mode by following the instructions in FIG-7 at left. A "P" will appear on the LED display as you enter program mode.

2. Release the Push-to-talk button after the beeping has stopped. The radio will display a series of six characters for Radio Identification, with each character separated by a hyphen. The 1st two characters indicate the model number, the 3rd and 4th characters indicate the radio type, and the 5th and 6th characters indicate the firmware revision.

In this example:      Model:                    A5  
                                 Radio Type:                15  
                                 Firmware Revision:      01

NOTE: Radio models with firmware revisions prior to 15.01 do not display the Radio Identification sequence.

3. After the Radio Identification has been displayed the digit 1 will appear, followed by a hyphen, and the radio will emit a triple beep indicating that the radio is in program mode.

4. Turn the radio OFF and then ON again—the radio is now ready to use.

## CHANNEL SCAN: HOW TO TURN ON/ OFF

1. Follow the instructions in FIG-7 at left to place the radio in the Program/ Readout Mode.
2. The radio will display the Radio Identification code, then emit a triple beep indicating that the radio is in program mode.
3. Using the PTT (push-to-talk) button and the LED display, enter a single digit code "1" to turn channel scan on, or code "2" to turn channel scan off.
4. Pause—the display will change and show a hyphen, you will also hear a short low tone.
5. Press and release the On/ Volume Up to **SAVE** your programming entry. The radio will sound a triple beep to indicate that programming was successful.
6. Turn the radio OFF and then ON again—the radio is now ready to use.

# RADIO PROGRAMMING

## **WEATHER CHANNEL: HOW TO TURN ON/ OFF**

1. Follow the instructions in FIG-7 to place the radio in the Program/ Readout Mode.
2. The radio will display the Radio Identification code, then emit a triple beep indicating that the radio is in program mode.
3. Using the PTT (push-to-talk) button and the LED display, enter a single digit code "3" to turn weather channel on, or code "4" to turn weather channel off.
4. Pause—the display will change and show a hyphen, you will also hear a short low tone.
5. Press and release the On/ Volume Up to **SAVE** your programming entry. The radio will sound a triple beep to indicate that programming was successful.
6. Turn the radio OFF and then ON again—the radio is now ready to use.

## **WEATHER ALERT: HOW TO TURN ON/ OFF**

1. Follow the instructions in FIG-7 to place the radio in the Program/ Readout Mode.
2. The radio will display the Radio Identification code, then emit a triple beep indicating that the radio is in program mode.
3. Using the PTT (push-to-talk) button and the LED display, enter a single digit code "5" to turn weather alert on, or code "6" to turn weather alert off.
4. Pause—the display will change and show a hyphen, you will also hear a short low tone.
5. Press and release the On/ Volume Up to **SAVE** your programming entry. The radio will sound a triple beep to indicate that programming was successful.
6. Turn the radio OFF and then ON again—the radio is now ready to use.

## **PC PROGRAMMABLE FEATURES**

The SST "D-Series" handheld radio has many features available through PC programming. See your Ritron dealer or contact Ritron directly for PC programming of these option.

**Receive and Transmit Frequency** on any channel can be programmed to any valid frequency within it's designated band. (See "SST D-Series Model Numbers" for frequency bands)

**QC or DQC Selective Signaling** on any channel can decode and encode any of 51 available QC privacy codes or 83 available DQC digital privacy codes.

**Squelch Tightener** on any channel can adjust carrier squelch UP to block distant signals or DOWN to hear more distant signals.

**Wide or Narrow Band Transmit** on any channel.

**Transmit Power (SST-144D and SST-444D Only)** can be set on any channel to high or low power.

**Monitor Lock Out** can be set on any channel to prevent monitoring of the channel, only broadcasts with the correct QC or DQC code can be heard.

**Transmit Inhibit on Busy Channel** can be set on any channel to prevent transmitting when a broadcast is present on the receiver that does not carry the correct code. This feature is usually used in conjunction with Monitor Lock Out.

**Courtesy Beep** sounds a short tone at the end of each received transmission to indicate that the channel is clear and you may transmit.

**Transmit Clear To Talk Beep** Any channel can be set to sound a short tone after the PTT has been pressed to indicate that the radio is ready for you to begin talking.

**Transmit Time Out** time can be changed.

**Power Saver** "sleep" time can be set, or power saver can be disabled.

**Disable Field Programming** allows PC programming only.

**4-Hour Inactivity Turn-Off** can be set to turn the radio off automatically if not used for over 4 hours.

**Scan Channel** can be programmed or edited to include any of the radio channels, even channels that are not selected with the Channel Selector button. Other programmable scan features include scan resume delay time, busy channel blocking, last active channel beeps, and priority scanning options.

**2-Tone Paging Decode** can be set on any channel within a frequency range of 300-1500 Hz. Programmable options include the setting of the 2-tone frequencies and duration, all call, group call, call transpond, automatic setting of 2-tone decode when the channel is selected, automatic reset of the 2-tone decode if a call is not answered within 15 seconds, and automatically set the radio to carrier squelch mode after a 2-tone page is received.

**2-Tone Paging Encode** can be set on any channel within a frequency range of 300-1500 Hz. Programmable options include the setting of the 2-tone frequencies and duration, and a start delay time.

# BATTERIES

FIG-8: BATTERY ACCESS & INSTALLATION:

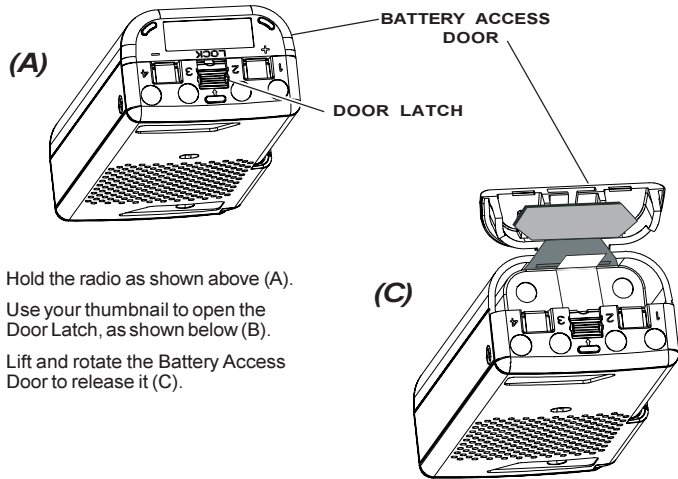

1. Hold the radio as shown above (A).
2. Use your thumbnail to open the Door Latch, as shown below (B).
3. Lift and rotate the Battery Access Door to release it (C).

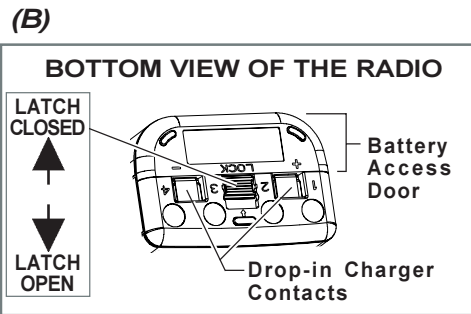

4. Use the Pull-tab to pull the battery pack out of the case (D).
5. Insert the replacement battery pack, being certain to POSITION IT RELATIVE TO THE CASE AS SHOWN IN (D). Push the Battery Pack in as far as possible.
6. Replace the Battery Access Door. Secure it by closing the Door Latch as shown in (B).
7. Be certain to firmly lock the Door Latch, as shown in (B).

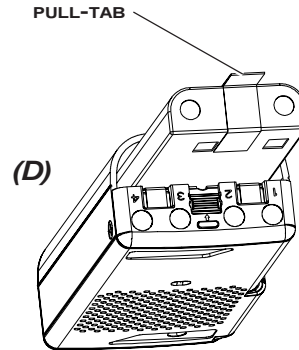

## OPTIONAL CHARGING ACCESSORIES:

Spare/ Replacement Battery Pack



Drop-in Battery Charger with spacer

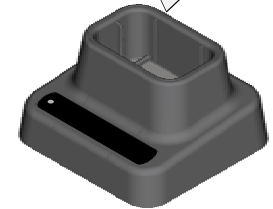

### JOBKOM JMX Accessories:

- BPJS-6N ..... 700 mAH Spare Battery Pack
- BPJS-AD ..... Drop-in Charger Adapter
- Quad Charger ..... 4-Unit Gang Charger

### PATRIOT SST Accessories:

- BPS-6N-SC ..... 800 mAH Spare Battery Pack
- BPS-6N-MH ..... 1500 mAH Spare Battery Pack
- BCPS-AD ..... Drop-in Charger Adapter
- BCC-PS ..... Drop-in Charger/ Conditioner

See Accessories on page ii.



# BATTERIES

**CAUTION:** Use only RITRON-supplied chargers; using other chargers may cause fire or explosion, or otherwise damage the radio.

## CHARGING

Because the battery pack loses its charge during storage and shipment, fully charge it before first use. To ensure peak radio performance for the next day, charge the battery overnight after each day of use. It completely charges in about ten hours.

### TO CHARGE THE BATTERY WITH A RITRON CUBE CHARGER

Plug the charger cord into the charge jack (marked "CHG") on top of the radio. Then plug the cube into an 110 VAC outlet. The green lamp lights while the battery is charging, and should go out only when the cube or cord is unplugged.

### TO CHARGE THE BATTERY WITH A RITRON DROP-IN CHARGER

Two charger contacts, visible through the radio case bottom, permit charging the battery with an optional Ritron drop-in charger. The battery pack may be either removed from the radio case for charging, or charged inside the radio case.

Each drop-in charger comes with a spacer to permit charging a "spare" battery while the radio is being used.

To use the drop-in charger, plug it into a 110 VAC outlet. Set either the radio with the battery installed, or only the battery with the battery spacer, into the charger. Refer to the illustration in Optional Accessories, opposite. Each battery contact must rest on a charger contact pin.

## NOTE:

**Battery pack life averages one year. Follow these guidelines to maximize service life:**

- CONDITION battery packs once a month as directed in Battery Maintenance & Conditioning, at right.
- CONDITION batteries that are run down.
- CHARGE batteries for 16 hours before storage, and for 16 hours once a month thereafter.
- DO NOT overcharge batteries. Unplug the cube charger after 16 hours to avoid overcharging.
- DO NOT charge batteries in temperatures colder than about 45°F. Charging batteries in temperatures above 95°C. does not harm them, but can reduce charge capacity.

## BATTERY MAINTENANCE & CONDITIONING

Due to the extended run time of the SST Series radios, some users may never fully discharge the NiCad battery pack during normal use. Achieve maximum battery life by fully discharging the battery periodically to condition it.

After exposing the battery pack to many cycles of not fully discharging it before recharging, the radio may exhibit reduced battery capacity. This reduced capacity is evident when, after several hours of use, battery voltage drops while the radio is transmitting, causing the radio to emit a dead battery warning tone and shut itself off.

Condition battery packs by the following procedure as either a preventive measure, or if you suspect reduced capacity:

### TO CONDITION THE BATTERY PACK:

1. Use your radio throughout a normal work day without charging.
2. • Press and hold the On/ Volume Up and Volume Down/ Off buttons simultaneously for 8 seconds to place the radio in "open squelch" mode.
  - Release both buttons when you hear the radio beep rapidly; it will then emit a loud "rushing" noise. Press On/ Volume Up to maximize this noise.
3. • Put the radio away in a secure place (possibly a desk drawer), where nothing can press against the buttons to accidentally turn it off or cause it to transmit. Allow the radio to run until it shuts off when the battery is completely discharged. A typical battery pack may require about 8 hours to completely discharge.
4. • When the radio has shut off, charge it overnight for 12-14 hours. The battery will be ready for use with renewed capacity.

**NOTE:** A new battery must be charged and discharged several times before it can reach its maximum charge capacity.

# !! CAUTIONS—ALL RADIOS !!

## **OBSERVE CAUTION IN THE FOLLOWING ENVIRONMENTS TO MAXIMIZE THE LIFE OF YOUR RADIO EQUIPMENT:**

**MOISTURE:** SST Series radios are not waterproof. DO NOT directly expose them to rain or excessive moisture.

**CHEMICALS:** Detergents, alcohol, aerosol sprays or petroleum products can damage the radio case. DO NOT use petroleum solvents of any kind; use a soft cloth moistened with water to clean the case.

**EXTREME HEAT:** High temperatures can damage the battery and other components. DO NOT expose the units to extreme heat or leave them in direct sunlight.

**LOW TEMPERATURES:** The capacity of the rechargeable battery is greatly reduced in extreme cold. When using the unit in very cold environments, periodically warm the radio under your coat.

**EXCESSIVE TRANSMISSIONS:** Maximum drain on battery power occurs when you are transmitting. DO NOT hold the Push-To-Talk switch down longer than necessary during transmission intervals. DO NOT reduce battery service life by attempting to power a radio with a depleted battery; always charge batteries overnight after each day of use.

**VIBRATION/ SHOCK:** Although your SST Series radio is designed to be rugged, it will not survive excessive abuse. Avoid dropping the radio.

**NOTE:** The optional MH-A holster provides added protection from weather and shock.

## **EXPOSURE TO RADIO FREQUENCY ENERGY**

The JMX/SST Series handheld radios generate RF electromagnetic energy during transmit mode. The transmit mode is active when the PTT switch is depressed. This radio is designed for, and classified as, "Occupational Use Only", meaning that it must be used only during the course of employment by individuals who are aware of the hazards and the ways to minimize such hazards. This series of radios is NOT intended for use by the "General Population" in an uncontrolled environment.

When used as directed, this series of radios is designed to comply with the FCC's RF exposure limits for "Occupational Use Only". In addition, they are designed to comply with the following Standards and Guidelines:

- FCC OET Bulletin 65, Edition 97-01, Supplement C, Evaluating Compliance with FCC Guidelines for Human Exposure to Radio Frequency Electromagnetic Fields.
- American National Standards Institute (C95.1-1992), IEEE Standard for Safety Levels with Respect to Human Exposure to Radio Frequency Electromagnetic Fields, 3 kHz to 300 GHz.
- American National Standards Institute (C95.3-1992), IEEE Recommended Practice for the Measurement of Potentially Hazardous Electromagnetic Fields-RF and Microwave.

To ensure that exposure to RF electromagnetic energy is within the FCC allowable limits for occupational use, always adhere to the following guidelines:

- Use only the antenna(s) available from RITRON for these models. **DO NOT** attempt to substitute any other antenna. **DO NOT** operate the radio without an antenna.
- Keep talk times as short and infrequent as possible. **DO NOT** depress the PTT button when not actually wishing to transmit. These radios are equipped with an internal timer to limit continuous transmit times. **DO NOT** exceed a 50% transmit duty cycle.
- When transmitting, hold the radio in front of the mouth at a distance of at least 4 inches. **DO NOT** hold the radio in such a manner that the antenna is next to, or touching, exposed parts of the body, especially the face or eyes while transmitting.
- In belt mounted applications, when transmitting, remove the radio from the belt and hold away from the body at least 4 inches.
- When using external headset accessories, hold the unit away from the body at least 4 inches while transmitting.
- **DO NOT** allow children to operate the radio.

# TROUBLESHOOTING

## NOTES

- Try a battery pack from a working radio. If the radio in question works with that pack, the original battery is suspect.
  - Charge the suspect battery as recommended in this manual. If this original battery cannot power the radio, try charging it again with another charger. If the battery still doesn't hold a charge, the pack should probably be replaced.
  - If the battery appears to be "good" after using the second charger, the first charger may be faulty. Contact a dealer or Ritron about an accessory that is not operating properly.
- Reception can often be improved if you relocate by a short distance. This effect is more noticeable inside buildings.
  - The range for SST radios is about two miles, line-of-sight.
- If your radio does not detect calls from other radios on the channel, turn off Quiet Call by pressing and holding both volume buttons at the same time—a double beep indicates Quiet Call is off.
- Without use of a repeater: To hear a call, select a channel programmed to receive the caller's transmit frequency. To call another unit, select a channel programmed to transmit the other radio's receive frequency.
  - Using a repeater: A radio channel can hold two separate operating frequencies, one for receive and one for transmit. Your channel must work with the repeater's transmit and receive frequencies.
- Maximum power drain occurs when the radio transmits, so don't hold down the PTT more than needed to transmit.
  - Battery power is used while the handheld is left on to receive calls. If practical, switch off the unit.
- Battery capacity is greatly reduced in extreme cold.
  - To use the radio in very cold weather, periodically warm it under your coat if possible.
  - An optional remote speaker/microphone allows keeping the radio under your coat while transmitting and receiving.
- To "talk" with each other, radios must be programmed identically for Quiet Call code, as well as frequency. Each code is unique; radios respond only to the code programmed.
  - Press and hold both volume buttons at the same time. A single beep indicates Quiet Call squelch is on. A double beep indicates Quiet Call squelch is off.

## CHART

If you have trouble operating the handheld, review the Control & Operation, pages 2 through 7. If you think the radio is malfunctioning, check the list below.

Problem	Possible Solutions
<b>GENERAL</b>	
The radio does not work at all.	<ul style="list-style-type: none"> <li>• Make sure that the battery is installed correctly, as shown in FIG-8, page 11.</li> <li>• Recharge or replace the battery. (See pages 11 &amp; 12.)</li> </ul>
Operating features do not work exactly as expected.	<ul style="list-style-type: none"> <li>• The radio has been dealer programmed for customized operation. (Consult dealer.)</li> </ul>
Reception is poor.	<ul style="list-style-type: none"> <li>• Move to a different location. (See Note 2.)</li> <li>• Confirm the proper antenna is connected to the radio. (See page 2, Antenna)</li> </ul>
You cannot hear calls from other radios.	<ul style="list-style-type: none"> <li>• Turn off Quiet Call (coded) squelch. (See Note 3.)</li> <li>• Ensure radio receives on the same frequency as the caller transmits. (See Note 4.)</li> <li>• Recharge the battery. (See Note 1.)</li> </ul>
Your calls cannot be heard in other radios.	<ul style="list-style-type: none"> <li>• Make sure that your radio transmits on the receive frequency of the radio(s) you want to call. (See Note 4.)</li> <li>• Recharge the battery.</li> </ul>
<b>BATTERY</b>	
Battery loses charge sooner than expected.	<ul style="list-style-type: none"> <li>• Review battery charging instructions, page 12.</li> <li>• Conserve the battery. (See Note 5.)</li> <li>• If the radio is used in extreme cold, warm the radio under your coat. (See Note 6.)</li> <li>• Replace the battery; see FIG-8, page 11. (See Note 1.)</li> </ul>
<b>ERRORTONES</b>	
An error tone sounds when the radio is first switched on.	<ul style="list-style-type: none"> <li>• See "Error Tones" on page 4.</li> </ul>
An error tone occurs while transmitting.	<ul style="list-style-type: none"> <li>• Refer to "Transmitter Time-Out," page 4.</li> <li>• Refer to "Recharge Battery Alert," page 4.</li> </ul>
<b>QUIETCALL</b>	
You cannot screen out calls from users outside of your Quiet Call group.	<ul style="list-style-type: none"> <li>• Make sure that the channel is programmed with Quiet Call.</li> <li>• Activate coded squelch. (See Note 7.)</li> </ul>
You cannot hear Quiet Call messages while in Quiet Call (coded) squelch.	<ul style="list-style-type: none"> <li>• Confirm that the channel is programmed to detect the same code as the calling radio(s) transmits. (See Note 7.)</li> </ul>
Others in your Quiet Call group cannot hear your Quiet Call messages.	<ul style="list-style-type: none"> <li>• Verify that you transmit the same code as the radio(s) you call are programmed to detect. (See Note 7.)</li> </ul>

# FCC LICENSE REQUIRED

## FCC REGULATIONS

### LICENSING —

The FCC requires the owners of the radios to obtain a station license before using them.

The station licensee is responsible for ensuring that transmitter power, frequency and deviation are within the limits specified by the station license. The station licensee is also responsible for proper operation and maintenance of the radio equipment. This includes checking the transmitter frequency and deviation periodically, using appropriate methods.

To get a FCC license for VHF or UHF frequencies, submit FCC application Form 600 as indicated in the block at right. Your Ritron dealer can help you with this process.

### SAFETY STANDARDS —

The FCC (with its action in General Docket 79-144, March 13, 1985) has adopted a safety standard for human exposure to radio frequency electromagnetic energy emitted by FCC regulated equipment. Ritron observes these guidelines and recommends that you do also:

- DO NOT hold the radio so that the antenna is very close to or touching exposed parts of the body, especially the face or eyes, while transmitting. Keep the radio vertical, four inches away while talking into the front panel.
- DO NOT press the Push-To-Talk except when you intend to transmit.
- DO NOT operate radio equipment near electrical blasting caps or in an explosive atmosphere.
- DO NOT allow children to play with any radio equipment that contains a transmitting device.
- Repair of Ritron products should be performed only by Ritron authorized personnel.

## SERVICE

Federal law prohibits you from making any internal adjustments to the transmitter, and/ or from changing transmit frequencies unless you are specifically designated by the licensee.

If your radio equipment fails to operate properly, or you wish to have the radio programmed, contact your authorized dealer or Ritron.

## HOW TO OBTAIN AN FCC RADIO LICENSE

### Federal Communications Commission (FCC) Licensing Information

Because your Ritron radio operates on Private Land Mobile frequencies, it is subject to the Rules and Regulations of the FCC, which requires all operators of these frequencies to obtain a station license before operating their equipment. Make application for your FCC license on FCC Forms 600 and 159.

*To have forms and instructions faxed to you by the FCC, call the **FCC Fax-On-Demand** system at **202-418-0177** from your fax machine; request Document 000600 & Form 159.*

*To have Document 000600 & Form 159 mailed to you, call the **FCC Forms Hotline** at **800-418-FORM** (800-418-3676).*

*For help with questions concerning the license application, contact the FCC at **888-CALL-FCC** (888-225-5322).*

*You must decide which radio frequency(ies) you can operate on before filling out your application; refer to Table 1 on page 5 of this manual. For help determining your frequencies, call Ritron at **800-USA-1-USA** (800-872-1872).*

# RITRON, INC. LIMITED WARRANTY

## WHAT THIS WARRANTY COVERS

RITRON, INC. ("RITRON") provides the following warranty against defects in materials and/or workmanship in **RITRON Radios, Rechargeable Batteries and Accessories** under normal use and service during the applicable warranty period (as stated below). "Accessories" means antennas, holsters, chargers, earphones, speaker/microphones and items contained in the programming and programming/service kits. Rechargeable batteries will be replaced during the applicable warranty period only if leakage occurs or the batteries drop below 75% of rated capacity.

<u>WHAT IS COVERED FOR</u>	<u>HOW LONG</u>	<u>WHAT RITRON WILL DO</u>
Portable SST D-Series Radios	1 year*	During the first year after date of purchase, RITRON will repair or replace the defective product, at RITRON's option, parts and labor included at no charge.
RITRON Rechargeable Batteries	1 year*	RITRON will replace the defective battery
Accessories	90 days*	* After date of purchase

## WHAT THIS WARRANTY DOES NOT COVER:

- Any technical information provided with the covered product or any other RITRON products;
- Installation, maintenance or service of the product, unless this is covered by a separate written agreement with RITRON;
- Any products not furnished by RITRON which are attached or used with the covered product, or defects or damage from the use of the covered product with equipment that is not covered (such as defects or damage from the charging or use of batteries other than with covered product);
- Defects or damage, including broken antennas, resulting from:
  - misuse, abuse, improper maintenance, alteration, modification, neglect, accident or act of God,
  - the use of covered products other than in normal and customary manner or,
  - improper testing or installation;
- Defects or damages from unauthorized disassembly, repair or modification, or where unauthorized disassembly, repair or modification prevents inspection and testing necessary to validate warranty claims;
- Defects or damages in which the serial number has been removed, altered or defaced.
- Batteries if any of the seals are not intact.

**IMPORTANT:** This warranty sets forth the full extent of RITRON's express responsibilities regarding the covered products, and is given in lieu of all other express warranties. What RITRON has agreed to do above is your sole and exclusive remedy. No person is authorized to make any other warranty to you on behalf of RITRON. Warranties implied by state law, such as implied warranties of merchantability and fitness for a particular purpose, are limited to the duration of this limited warranty as it applies to the covered product. Incidental and consequential damages are not recoverable under this warranty (this includes loss of use or time, inconvenience, business interruption, commercial loss, lost profits or savings). **Some states do not allow the exclusion or limitation of incidental or consequential damages, or limitation on how long an implied warranty lasts, so the above limitations or exclusions may not apply to you. Because each covered product system is unique, RITRON disclaims liability for range, coverage, or operation of the system as a whole under this warranty.**

## WHO IS COVERED BY THIS WARRANTY

This warranty is given only to the purchaser or lessee of covered products when acquired for use, not resale. This warranty is not assignable or transferable.

## HOW TO GET WARRANTY SERVICE

To receive warranty service, you MUST deliver or send the defective product, delivery costs and insurance prepaid, within the applicable warranty period, to RITRON, INC., 505 West Carmel Drive, Carmel, Indiana 46032, Attention: Warranty Department.

Please point out the nature of the defect in as much detail as you can. **You MUST retain your sales or lease receipt (or other written evidence of the date of purchase) and deliver it along with the product.** If RITRON chooses to repair or replace a defective product, RITRON may replace the product or any part or component with reconditioned product, parts or components. Replacements are covered for the balance of the original applicable warranty period. All replaced covered products, parts or components become RITRON's property.

## RIGHTS TO SOFTWARE RETAINED

Title and all rights or licenses to patents, copyrights, trademarks and trade secrets in any RITRON software contained in covered products are and shall remain in RITRON. RITRON nevertheless grants you a limited non-exclusive, transferable right to use the RITRON software only in conjunction with covered products. No other license or right to the RITRON software is granted or permitted.

## Your Rights Under State Law

This warranty gives you specific legal rights, and you may also have other rights which vary from state to state.

## WHERE THIS WARRANTY IS VALID

This warranty is valid only within the United States, the District of Columbia and Puerto Rico.



Designed to work as an integrated system or as an add-on to virtually any existing two-way radio system



**Quick Talk™**  
Wireless Voice Alarm Reporter  
for Remote Monitoring of any  
sensor or switch



**OutPost™ XT**  
Ruggedized Two-Way Callbox  
Battery-operated callboxes provide instant wireless communication over existing two-way radio systems



**OutPost™**  
Basic Two-Way Callbox



**Quick Assist® II**  
Push-Button RF Transmitter



**Desktop or Wall Mountable**  
2-Way Base Station

