

6



Series OUTPOST[®] Owner's Manual

- For Serial #'s 13250 or Higher – Use Ritron Pub No. 14500055 – “6” Series Owners Manual.
- For Serial #'s 13249 or Lower – Use Ritron Pub No. 14500042 – “6” Series Owners Manual.

TABLE OF CONTENTS

Basic Operation

6 SERIES OUTPOST® CALLBOX MODELS 1
 ABOUT THE 6 SERIES OUTPOST® CALLBOX 2
 OPERATING THE 6 SERIES OUTPOST® CALLBOX WITH
 FACTORY DEFAULT SETTINGS..... 3
 EXPOSURE TO RADIO FREQUENCY ENERGY 3

Installation Instructions

APPLYING POWER TO THE OUTPOST® CALLBOX..... 4
 POWER MANAGEMENT OPTIONS..... 5
 Using Rechargeable Batteries for Battery Back-up 5
 FIG-1: Charge Jumper Shown in Charge Position 5
 FIG-2: Sensor Turn-On Jumper Shown in Turn-On Position 5
 CALLBOX CONTROLS AND CONNECTORS..... 6
 FIG-3: Callbox Assembly, Controls and Connectors 6
BASIC OUTPOST® INSTALLATION INSTRUCTIONS..... 7
 COVERAGE 7
XT OUTPOST® INSTALLATION INSTRUCTIONS 7
 FIG-4: XT Callbox Mounting Brackets..... 7
 OPTIONAL XT OUTPOST® MOUNTING BRACKET
 INSTALLATION INSTRUCTIONS 8
 FIG-5: Optional XTMK Mounting Bracket XT Callbox 8
 HOW TO SEAL THE ANTENNA..... 8

Field Programming

HOW TO READOUT CURRENT RADIO FREQUENCY & TONE
 CODES 9
 HOW TO FIELD PROGRAM FREQUENCY & TONE CODES ... 10
 HOW TO FIELD PROGRAM 2-TONE DECODE (RECEIVE)
 CODES 11
 TABLE 1: PROGRAMMABLE FREQUENCY CODES 12
 CANADIAN FREQUENCY CODES..... 12
 TABLE 2: INTERFERENCE ELIMINATOR PROGRAMMABLE QC
 TONE CODES 13
 TABLE 3: DIGITAL INTERFERENCE ELIMINATOR
 PROGRAMMABLE DQC TONE CODES 13
 TABLE 4: PROGRAMMABLE 2-TONE DECODE (RECEIVE)
 CODES 13
 HOW TO FIELD PROGRAM SINGLE-DIGIT RADIO FEATURE
 CODES 14
 TABLE 5: SINGLE-DIGIT RADIO FEATURE CODES 14
 HOW TO FIELD PROGRAM ADVANCED FEATURE CODES... 15
 TABLE 6: ADVANCED FEATURE CODES 15

Programmable Features

PROGRAMMABLE OUTPOST® CALLBOX FEATURES..... 17
 Glossary of Terms..... 17
 INTERCOM (ALWAYS-ON) PROGRAMMING..... 19
 USEFUL FEATURES TO USE WITH INTERCOM (ALWAYS-ON)
 PROGRAMMING..... 19
 SWITCH OUTPUT OPTIONS - ALLOWS CONTROL OF AN
 EXTERNAL DEVICE 20
 2-TONE DECODE (RECEIVE) SETTINGS 21

GateGuard® Application

Configuration for the Remote Control of a Gate Controller

CONFIGURING THE CALLBOX FOR A GATEGUARD®
 APPLICATION 22
 FIG-6: XT CALLBOX ASSEMBLY 23
 Table 7: XT Callbox 6-Conductor Interface Cable..... 23
 HOW TO FIELD PROGRAM THE OUTPOST® CALLBOX FOR
 GATEGUARD® OPERATION 24
 OPTIONAL GATEGUARD® SETTING/FEATURES 24

Licensing

FCC Licensing 26
 How to Obtain an FCC Radio License 26
 Safety Standards..... 26
 INDUSTRY CANADA Regulations 26
 INDUSTRY CANADA License Application 26
 Service 26

Warranty

RITRON, INC. LIMITED WARRANTY..... 27

6 SERIES OUTPOST® CALLBOX MODELS.....

VHF MODELS

- RQX-156 VHF Basic Callbox
- RQX-156-XT VHF Vandal-Resistant XT Callbox
- RQX-156-XT-KP VHF Vandal-Resistant XT Callbox with Keypad

UHF MODELS

- RQX-456 UHF Basic Callbox
- RQX-456-XT UHF Vandal-Resistant XT Callbox
- RQX-456-XT-KP UHF Vandal-Resistant XT Callbox with Keypad

The model number appears on the serial label located on the front of the basic Callbox enclosure, behind the removable faceplate. On XT models the standard enclosure is located inside the fiberglass reinforced vandal-resistant box.



Basic Callbox XT Callbox

VHF radios are designed to operate within the 15 MHz band between factory standard 150 and 165 MHz.

UHF radios are designed to operate within the 20 MHz band between factory standard 450 and 470 MHz.

OPTIONAL ACCESSORY EQUIPMENT

Several options are available for the Ritron 6 Series OUTPOST® Callbox. These options, individually, or in combination with one another can greatly enhance the functionality of the callbox as well as the overall communication system. Available options include:

- **Entry Keypad** – RQX-156-XT-KP and RQX-456-XT-KP “keypad versions” of the 6 Series Outpost callbox are available to allow local access with up to 500 unique codes. This version hosts a 2x6 DTMF keypad mechanically mounted to the stainless steel faceplate.
- **RSS-100** - The RSS-100 is a complete solar power supply system consisting of a 10-watt solar panel, charge controller and 8 AH rechargeable battery all housed in a rugged, ready-to-mount enclosure.
- **R-STROBE** - The R-STROBE is a powerful strobe light, giving a visual indication of a callbox in use. The R-STROBE is available in both AC (R-STROBE) and DC versions (R-STROBE-DC).
- **RCIM-1000** - The RCIM-1000 MDC-1200 encoder board allows each callbox to be assigned a unique unit ID number.
- **GGT-1** - The GGT-1 DTMF decoder/relay board allows remote control of the on-board relay (e.g. Gateguard® operation) with a DTMF keypad equipped radio.
- **RQX-XTMK** – The RQX-XTMK is a mounting plate used to mount the XT callbox to most flat surfaces.
- **RQX-XTMK-GN** – The RQX-XTMK-GN is a mounting bracket used to mount the XT callbox to an industry standard gooseneck post.

For additional information and pictures of these items go to <http://www.ritron.com/callboxes.html> and download pdf of the product brochure.



XT Callbox with Keypad



RSS-100

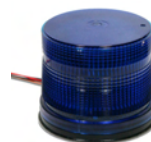

R-STROBE



RQX-XTMK-GN

ABOUT THE 6 SERIES OUTPOST® CALLBOX.....

The 6 Series OUTPOST® Callbox is a 2-way radio transceiver used to communicate directly with portable, mobile and stationary radios; or through radio repeaters with Ritron PC Programming software. Each callbox is equipped with the following features or capabilities.

- **Field Programming.** Field programming allows you to quickly program your radio in the field without the need for a PC programmer. Each radio can be field programmed to one of 26 VHF or 77 UHF channel table frequencies, and one of 50 QC or 104 DQC interference eliminator codes.
 - **VHF “License Free” Frequencies.** VHF models can be programmed from a list of 5 MURS frequencies that do not require FCC licensing.
 - **154 Interference Eliminator Codes.** Quiet Call (QC) and Digital Quiet Call (DQC) codes can be programmed to eliminate other radio users not in your workgroup. For compatibility, new radios should be programmed with the same codes.
 - **2-Tone Decoding.** The Callbox can be programmed to decode unique 2-tone codes for selective signaling of the Callbox, “Listen In” remote activation of the transmitter, or Switch Output activation in GateGuard® applications.
 - **Wide or Narrow Band Operation.** The radio can be programmed for wide or narrow operation by selecting from a wide variety of field programmable table frequencies, or by PC programming.
 - **Volume Level.** Field programmable to one of 5 preset levels and PC programmable to 2 – 100% volume level.
 - **Normal or High Microphone Gain.** Field and PC programmable to normal or high microphone gain.
 - **High/Low Power Output.** The callbox can be Field programmed for transmitter power output.
 - **VHF:** 1 Watt
 - **UHF:** 1 Watt or 2 Watt*
- * See “Special Note” on page 4.
- **Battery Powered.** The OUTPOST® Callbox is powered by 6 Alkaline, D-cell batteries that can operate the radio for up to one year or 7,000 transmissions.
 - **External Power +12 VDC Capable.** The Basic and XT models are capable of being powered by an external +12 VDC source. This method of powering the callbox allows the radio to remain **ON** at all times, like an intercom. Automatic Turn Off must be **DISABLED** via Field or PC programming for Intercom operation.
 - **Low Battery Alert.** The callbox will transmit an Alert Tone at the end of each transmission when the batteries approach end-of-life. This allows sufficient time for you to replace the batteries and assure uninterrupted service.
 - **+12 VDC Power Fail Alert.** This feature can be enabled via Field or PC programming. The callbox will transmit an Alert Tone if it detects loss of +12 VDC power. This Alert Tone replaces a Low Battery Alert. The radio automatically continues to transmit an Alert Tone once every hour (unless programmed for Automatic Turn Off) until +12 VDC is restored or the batteries are depleted.
 - **Companded Audio.** The radio can be Field or PC programmed to **ENABLE** or **DISABLE** audio companding. Companding will compress transmit audio before sending it, and expand receive audio before it is heard on the speaker to reduce the background noise common in radio communications.
 - **“Automatic Turn-Off” or “Intercom” Operation.** The 6 Series OUTPOST® Callbox can operate in the standard “Automatic Turn-Off” mode (Factory Default), where the radio is normally **OFF** until the Call Button is pressed, or can be Field or PC programmed for “Intercom” operation where the radio is always **ON**. See “External Power +12 VDC Capable” feature above.
 - **Listen In.** Allows remote activation of the transmitter when a unique 2-Tone code is received. Field programmable to one of 9 different 2-Tone codes and 4 different Listen In transmit times.
 - **DTMF or Selcall ANI.** 1-9 digit DTMF or 3-7 digit Selcall codes can be transmitted at the beginning of each message for radio identification.
 - **Sensor Turn-On.** When operating the Callbox with Automatic Turn-Off enabled, the unit can be configured to turn itself **ON** any time the Sensor Input is pulled **LOW** (ground). This allows an external switch closure to activate the Callbox.

OPERATING THE 6 SERIES OUTPOST® CALLBOX WITH FACTORY DEFAULT SETTINGS

The 6 Series OUTPOST® Callbox Factory Default setting is with Automatic Turn Off **ENABLED**. This means the callbox is **OFF** and will not receive a call until the callbox first initiates a call.

In Automatic Turn Off mode the callbox automatically shuts off whenever there is “no activity” for ten (10) seconds.

To Initiate a Call

Press and hold the **ON/PTT** Button. The callbox will send a unique **CALL TONE** to alert radio equipped personnel. This **CALL TONE** will also be heard at the callbox. Listen for the “beep”, then, begin speaking into the MIC. For best communication, the caller should be 3 feet or less from the microphone.

To Receive a Call

1. When you have finished speaking, release the **ON/PTT** Button.
2. Any reply will be heard through the callbox speaker. If a call is not received within 10 seconds of releasing

the **ON/PTT** Button and there is no activity on the channel, the callbox will sound a low double tone and turn-off automatically. This automatic turn-off feature is designed to conserve battery life.

Operation Notes

The 6 Series OUTPOST® must be powered with D-cell Alkaline batteries **ONLY**, or alternatively, with an external 12 VDC power supply, order Ritron model **RPS-EXPO** 110 VAC to 12 VDC cube power supply. When using an external 12 VDC supply, Alkaline or NiCd batteries can be used as back-up. See page 4.

If there has been no activity for 10 seconds, i.e. either the **ON/PTT** Button has not been pressed or a call has not been received, the unit automatically shuts **OFF**.

Low Battery Alert

The callbox will transmit an Alert Tone at the end of each transmission when the batteries approach end-of-life. This allows sufficient time for you to replace the batteries and assure uninterrupted service.

EXPOSURE TO RADIO FREQUENCY ENERGY

These products generate radio frequency (RF) energy when the ON/PTT button on the front of the unit is depressed. These products have been evaluated for compliance with the maximum permissible exposure limits for RF energy at the maximum power rating of the unit when using antennas available from RITRON.

These products are not to be used by the general public in an uncontrolled environment unless compliance with the Uncontrolled / General Population limits for RF exposure can be assured.

Antennas other than those available from RITRON listed below have not been tested for compliance and may or may not meet the exposure limits at the distances given. Higher gain antennas are capable of generating higher fields in the strongest part of their field and would, therefore, require a greater separation from the antenna.

RQX-456: For both the AFB-1545 and RAM-1545 antennas, at the 20 cm (7.9 inches) minimum expected separation distance and greater, the maximum RF exposure is well below the General Population / Uncontrolled limits.

RQX-156: To comply with the General Population / Uncontrolled limits, all persons must be at least 7.9 inches (20 cm) from the AFB-1545 antenna which is supplied by RITRON to be attached directly to the top of the unit. For the RITRON RAM-1545 magnet mount antenna, which can be located away from the unit, all persons must be at least 10.8 inches (28 cm) from the antenna.

To limit exposure to RF energy to levels below the limit, please observe the following:

- Use only the antenna(s) available from RITRON for these models. **DO NOT** operate the radio without an antenna.
- Keep talk times as short and infrequent as possible. **DO NOT** depress the **ON/PTT** button when not actually wishing to transmit. These radios are equipped with an internal timer to limit continuous transmit times.
- When transmitting, make certain that the distance limits for the particular model in use are observed.
- **DO NOT** allow children to operate the radio.

When used as directed, this series of radios is designed to comply with the FCC's RF exposure limits for “Uncontrolled / General Population”. In addition, they are designed to comply with the following Standards and Guidelines:

- FCC OET Bulletin 65, Edition 97-01, Supplement C, Evaluating Compliance with FCC Guidelines for Human Exposure to Radio Frequency Electromagnetic Fields.
- American National Standards Institute (C95.1-1992), IEEE Standard for Safety Levels with Respect to Human Exposure to Radio Frequency Electromagnetic Fields, 3 kHz to 300 GHz.
- American National Standards Institute (C95.3-1992), IEEE Recommended Practice for the Measurement of Potentially Hazardous Electromagnetic Fields-RF and Microwave.

APPLYING POWER TO THE OUTPOST® CALLBOX

The Callbox may be powered:

- by six (6) D-cell batteries
- through an external +12 VDC source
- or both

Powering the callbox from internal batteries will allow for an installation that does not require wiring to an external source of power. Powering the callbox by an external source will allow the unit to remain **ON**, like an intercom*.

To provide a useful amount of battery life, one of two battery saver options should also be used. See “Power Management Options” on page 5.

* Automatic Turn Off must be **DISABLED** via Field or PC Programming

Using Internal Batteries

Six (6) D-cell batteries may be installed in the internal battery holder for a no trenching, no wires required installation. If internal batteries are used, a LOW battery alert tone will be transmitted when the battery voltage drops below a programmed value. The LOW battery tone notifies personnel that the batteries should be replaced.

! SPECIAL NOTE: It is recommended the UHF model is NOT set to operate in High Power when using **Alkaline** batteries. Due to the nature of alkaline batteries your transmit power output will decrease rapidly as the batteries are depleted.

Using External +12 VDC Power with Battery Back-up

Note: An additional hole, strain relief, and conduit will need to be installed into the callbox.

The unit may be powered by an external source of +12 VDC. This source should be filtered, with minimum noise and hum, and capable of supplying at least 1 Ampere.

Order Ritron model **RPS-EXPO** 110 VAC to 12 VDC cube power supply.



- Factory Default programming of the callbox is optimized for battery power operation. The External +12 VDC Power Fail Alert option is **NOT ENABLED**.
- It is recommended that if an external source of power is used, that the internal batteries be installed as a back-up against loss of power. If this option is chosen, we recommend that the “External +12 VDC Power Fail Alert” feature be **ENABLED** via Field or PC programming.

How the Callbox Operates:

If External +12 VDC Power Fail Alert Feature is NOT ENABLED:

- Radio always checks for LOW battery or DEAD battery condition when the radio is **ON**.
- If LOW battery is detected, a single Alert Tone will be transmitted at the end of the transmission.
- Radio does **NOT** automatically transmit a LOW battery tone. The callbox must be **ON** and Alert Tone is only sent at the end of a transmission.
- If DEAD battery is detected, the radio ceases all operation. A DEAD battery tone is heard on the callbox speaker and the radio will turn **OFF**.

If External +12 VDC Power Fail Alert Feature is ENABLED:

- Radio always checks for External +12 VDC when the radio is **ON**. If loss of External +12 VDC is detected while the radio is in standby: *a single Alert Tone will be transmitted immediately.*
- If loss of External +12 VDC is detected while the radio is in receive: *a single Alert Tone will be transmitted after the received message is complete.*
- If loss of External +12 VDC is detected while the radio is in transmit: *a single Alert Tone will be transmitted at the end of the transmission.*
- Once loss of External +12 VDC is detected and the Alert Tone is transmitted, the radio will automatically send the Alert Tone once every hour until External +12 VDC is restored or the batteries are exhausted. If radio is set for Automatic Turn-Off (default setting) this hourly alert will **NOT** occur.
- If Dead battery is detected the radio ceases all operation, a DEAD battery tone is heard on the callbox speaker and the radio will turn **OFF**.

POWER MANAGEMENT OPTIONS

There are four power management options available to the 6 Series OUTPOST® Callbox:

Automatic Turn-Off (Field or PC Programmable)

In this mode, the callbox will automatically turn itself off after a programmed period of no activity (**no transmissions made and no calls received**) has elapsed. Once the unit has turned itself off, it can only be turned back on by depressing the **ON/PTT** Button. The programmed period of no activity necessary before the unit turns itself off is called the **RQX Reset Time**. RQX Reset Time and Automatic Turn-Off can both be Field programmed, or PC programmed by the factory or your Ritron dealer via the Ritron RQX Series PC Programmer. Automatic Turn-Off mode is the factory default mode for power management with an RQX Reset Time of 10 seconds.

Battery Saver (PC Programmable Only)

This mode is similar to the Automatic Turn-Off mode except that the unit does **NOT** turn itself off after the RQX Rest Time has elapsed. Instead it reverts to a mode where the unit goes to sleep and periodically wakes up to test for receive activity on the channel. The Sleep Period (called Battery Saver Sleep Time) can be set using the Ritron RQX Series PC Programmer to between 0.5 and 8 seconds. Longer sleep times result in better battery life, but increase the chances that activity on the channel may be missed. The unit will come out of this mode when activity is detected during the wake-up period or if the **ON/PTT** button is pressed. The Automatic Turn-Off and Battery Saver modes cannot be used together.

Neither “Automatic Turn-Off” nor “Battery Saver” Used (Field or PC Programmable)

If neither Automatic Turn-Off nor Battery Saver are used the unit will consume the largest amount of current, but is always ready to instantly receive messages. This mode should only be considered if an external source of +12 VDC is available (see “Using External +12 VDC Power with Battery Back-up” on page 5).

Sensor Turn-On

When operating the Callbox with Automatic Turn-Off enabled, the unit can be configured to turn itself **ON** any time the Sensor Input is pulled **LOW** (ground). This allows an external switch closure to activate the Callbox.

When the switch closure is detected the Callbox will turn on and automatically transmit the Sensor On alert. The Callbox is then in normal operating mode and will automatically turn itself off after a programmed period of no activity as described in the Automatic Turn-Off topic in this section.

For Sensor Turn-On operation the Sensor Turn-On jumper must be placed into the “Turn-On” position. Refer to FIG-2 below for correct placement of the jumper. If the Sensor Input is not used the jumper placement has no effect on Callbox operation.

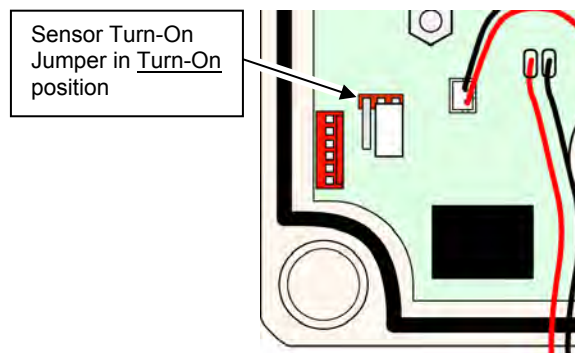

FIG-2: Sensor Turn-On Jumper Shown in Turn-On Position

Using Rechargeable Batteries for Battery Back-up

If rechargeable NiCd batteries are used for battery backup the “Charge Jumper” must be placed into the “charge” position as shown in FIG-1.

!! CAUTION !!

If rechargeable batteries are **NOT** used for battery backup, be sure the “Charge Jumper” is **NOT** in the “charge” position. Charging Alkaline batteries will damage the cells and reduce battery life!

Charge Jumper in Charge position

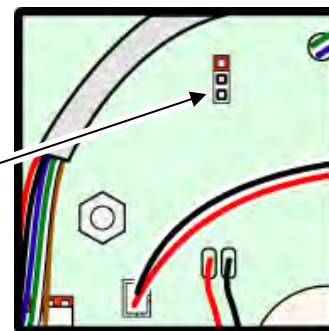

FIG-1: Charge Jumper Shown in Charge Position

CALLBOX CONTROLS AND CONNECTORS

Antenna Connector

The antenna radiates radio signals. Before using the OUTPOST® Callbox, make sure the antenna is securely fastened into the 50Ω BNC antenna connector. If the OUTPOST® is to be used outdoors, see page 8 for instructions on properly sealing the antenna connector.

RF Mating Connectors

An internal cable from the antenna connector is terminated into a phono style connector for connection to the radio circuit board.

Captive Plastic Case Screws

A captive plastic case screw is located in each corner of the case front. These 4 screws are used to secure the case front containing the radio, to the case back that contains the batteries.

Charge Jumper

The charge jumper can be set to trickle charge re-chargeable backup batteries.

Sensor Turn-On Jumper

The Sensor Turn-On jumper can be set to turn-on the radio whenever the Sensor Input is pulled low.

Input/Output Connector

The 6-pin, polarized connector is used to connect external input/output devices. This allows connection of an external +12 VDC input, an external DC level sensor input, and a 1A contact switch closure output.

Speaker Connector

The internal speaker is connected to the radio printed circuit board with a polarized connector.

On/PTT Connector

The On/PTT switch is connected to the radio printed circuit board with a polarized connector.

Pre-Drilled Mounting Holes

Mounting holes located in the 4 corners of the case back are pre-drilled for mounting to a plate, wall or post. Once mounted, the case front is secured to the case back through these same threaded holes.

RJ-11 Program Cable Connector

An RJ11 style connector is used to connect the cable from the PC programmer to the radio.

Program Button

A small, momentary pushbutton is used for field programming the OUTPOST® Callbox.

Program Display

A single digit LED display is used during field programming of the radio.

Battery Holder

The battery holder inside the case back is used for the installation of 6 D-cell alkaline batteries. Refer to the diagram below, or the labels beneath the cells, for correct installation of the batteries.

Battery Mating Connectors

Polarized, 2-pin mating connectors are used to connect the batteries to the radio circuit board.

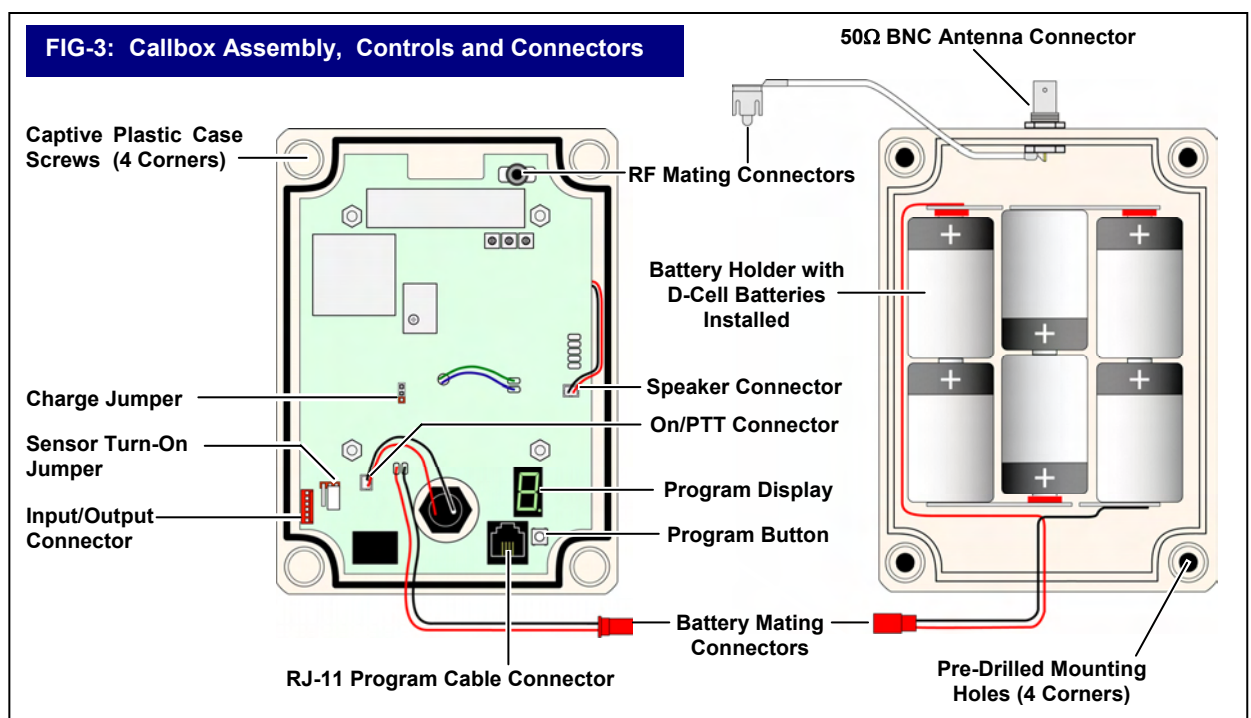

BASIC OUTPOST® INSTALLATION INSTRUCTIONS

The basic OUTPOST® can be mounted to virtually any surface with four (4) #6 panhead screws. Choose a type of screw thread and screw length which will hold firmly in the surface to which the unit will be mounted.

MOUNTING the OUTPOST®: (Refer to FIG-3)

- Loosen the (4) captive screws in the front corners of the case and separate the case front from the case back. These screws are captive to the housing; to prevent damaging them, **DO NOT** remove the screws from the housing.
- Install 6 D-cell alkaline batteries into the battery holder. Refer to FIG-3, or the labels beneath the cells, for correct installation of the batteries.
- If required, program the radio. Refer to the programming section of this manual for details.
- Disconnect the RF mating connectors and the battery mating connectors. Set the case front containing the radio circuit board aside.
- Insert a #6 panhead screw into each of the four (4) corner holes in the OUTPOST® case back. Position the case back in the chosen installation location and secure it in place with the four screws.
- Re-connect the RF mating connectors and the battery mating connectors between the case front and case back.
- Fasten the case front to the case back with the four (4) captive screws. Do not over-tighten the plastic screws to prevent damage.
- Insert, rotate and lock the antenna onto the antenna connector. Orient the antenna vertically.
- If the OUTPOST® is to be used outdoors, it is imperative that the antenna connector be sealed with sealing tape after the antenna has been installed. Use Grainger #2A-459, Radio Shack #278-1647, or equivalent. Refer to "HOW TO SEAL THE ANTENNA" instructions in this manual.
- To install the message placard, align the center of the hole over the **ON/PTT** Button, and the mushroom-head fastener strips on the back of the placard with the strips on the front of the OUTPOST® case. Press firmly to interlock the strips, snapping the panel into position.

CAUTION Do not drill or penetrate the OUTPOST® case with any additional holes. Use only the pre-drilled mounting holes.

COVERAGE

Depending on the unit location and installation, the OUTPOST® set for 1 Watt can cover up to 1 mile line of sight. To increase range, use an external antenna that is mounted higher. Contact RITRON for a RAM-1545 Magnet Mounted Antenna. Refer to Special Note on page 4.

XT OUTPOST® INSTALLATION INSTRUCTIONS

The XT OUTPOST® can be mounted to virtually any surface with four (4) ¼" diameter fasteners, not included. Choose a type of screw thread and screw length which will hold firmly in the surface to which the unit will be mounted.

MOUNTING the XT OUTPOST®: (Refer to FIG-4 and FIG-6 on page 23)

- Remove the front faceplate from the XT Callbox. The faceplate is secured to the case with 4 vandal-resistant buttonhead, Torx screws. Use the T-25 Torx bit included with the radio to remove these screws.
- Remove the "Mounting Bracket" kit secured to the inside of the XT Callbox case.
- Loosen the (4) captive screws in the front corners of the internal Callbox case and separate the case front from the case back. The screws are captive to the housing; to prevent damaging them, **DO NOT** remove the screws from the housing.
- Install 6 D-cell alkaline batteries into the battery holder. Refer to FIG-6, or the labels beneath the cells, for correct installation of the batteries.
- If required, program the radio. Refer to the programming section of this manual for details.
- Fasten the internal case front to the case back with the four (4) captive screws. To prevent damage, do not over-tighten the plastic screws.
- Re-fasten the front faceplate to the radio with the 4 buttonhead Torx screws.
- Install the 4 mounting brackets to the back of the XT Callbox case as shown in FIG-4 with the #10-32 bolts provided. The mounting brackets can be installed vertically, as shown, or horizontally.
- Position the XT Callbox in the chosen installation location and secure it in place with four screws through the mounting brackets.

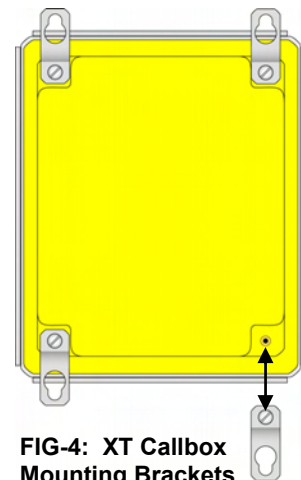

FIG-4: XT Callbox Mounting Brackets

OPTIONAL XT OUTPOST® MOUNTING BRACKET INSTALLATION INSTRUCTIONS.....

The optional XT Mounting Bracket (order part # XTMK) can be attached to the callbox for special applications with two (2) ¼" diameter fasteners, NOT included. Choose a type of screw thread and screw length which will fasten the callbox securely to the mounting surface.

MOUNTING the OPTIONAL XT OUTPOST® BRACKET: Refer to FIG-5 :

1. Using the XTMK bracket as a template, mark the two (2) holes #2 (see FIG-5) on the mounting surface you intend to fasten the bracket.
2. Find a flat work surface and using the included four (4) button head tamper resistant fasteners, attach the XTMK bracket to the existing holes on the back of the XT callbox (holes #1), as shown in FIG-5.
3. Secure the XTMK bracket to the mounting surface using holes #2 and two (2) ¼" fasteners (NOT included), as shown in FIG-5. Make sure mounting surface and fasteners are capable of supporting the total weight of the XT callbox.

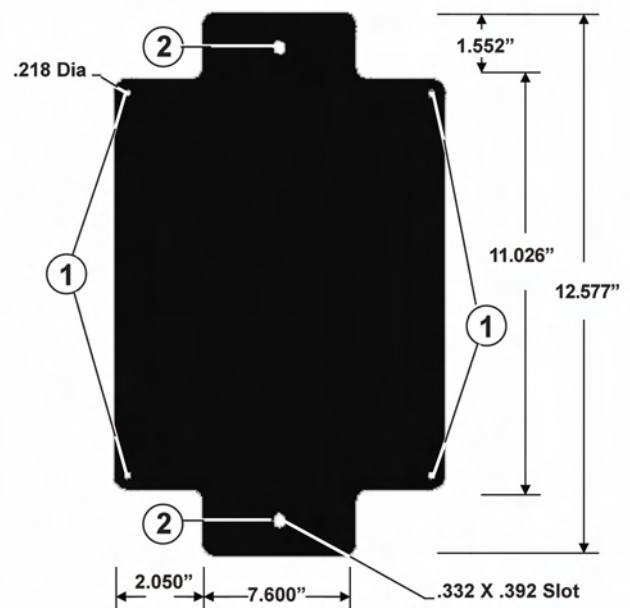

FIG-5: Optional XTMK Mounting Bracket XT Callbox

HOW TO SEAL THE ANTENNA

If the OUTPOST® Callbox is to be used outdoors it is imperative that the entire antenna connection be sealed with seal tape to provide proper operation and prevent voiding warranty.

Seal tape can be purchased at most Industrial Supply Stores, Hardware and Home Center Stores, or Electronic Supply Stores.

Regardless of the antenna used, it is always best to weatherproof the antenna connection using seal tape.

NOTICE

Failure to follow these instructions will cause damage to the product, prevent proper sealing of the enclosure and will void the Manufacturers Warranty.

Applying Seal Tape:

1. Attach the antenna to the 50Ω BNC connector on the OUTPOST® Callbox enclosure.
2. Begin wrapping seal tape at the base of the antenna connector such that it is sealed to the enclosure top.
3. Overlap the seal tape as you tightly wrap upward around the connector and antenna. Continue to overlap seal tape around the connector base, past the articulated portion of the antenna and several inches up the thin, shiny section of the antenna.

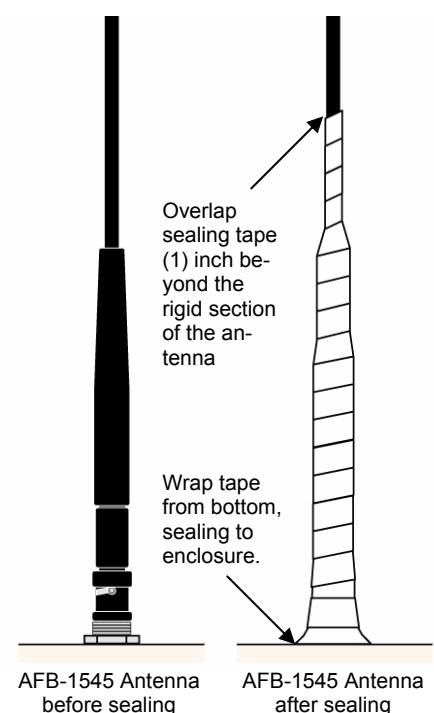

HOW TO READOUT CURRENT RADIO FREQUENCY & TONE CODES

- Loosen the (4) captive screws in the front corners of the case. These screws are captive to the housing; to prevent damaging them, DO NOT remove the screws from the housing.
- Separate the case front from the case back, leaving the batteries connected to the radio. Make sure the unit has batteries installed. **NOTE:** The voltage of the batteries must be greater than 6 VDC to program properly.
- Press and **RELEASE** the **ON/PTT** button on the front of the Callbox to turn the radio on.
- Press and **RELEASE** the Program button (See FIG-3 on page 6 for location). The radio will immediately begin to display a series of four digits; with each digit separated by a hyphen.

- Write down the four digits. The first two digits indicate the frequency code and the last two digits the tone code; see [Table 1](#) and [Table 2](#) on pages 12 and 13. In this example an RQX-456 is programmed to operate on the "Brown Dot" frequency of 464.500 MHz (Frequency code "04") with 100.0 Hz tone (Tone code "12").

FREQUENCY CODE

TONE CODE

- If a 5th digit is displayed, the channel has been programmed for DQC and the last three digits indicate the DQC code; see [Table 3](#) on page 13. In this example an RQX-456 was programmed to operate on the "Brown Dot" frequency of 464.500 MHz (Frequency code "04") with a DQC code of "723".

FREQUENCY CODE

DQC CODE

- If more than 5 digits are displayed, the radio has been programmed for 2-Tone Paging Decode. The frequency and tone codes will be displayed, followed by a "C", then the radio will display the 2-Tone paging code; see [Table 4](#) on page 13. In this example an RQX-456 was programmed to operate on the "Brown Dot" frequency of 464.500 MHz (Frequency code "04") with 100.0 Hz tone (Tone code "12") and 2-tone paging decode frequencies of 330.5 Hz and 569.1 Hz (2-Tone code "91").

FREQUENCY CODE

TONE CODE

PAGING CODE

- If the channel is PC programmed with any frequency or tone not listed in [Table 1](#), [Table 2](#) or [Table 3](#) on pages 12 and 13, the radio will sound the **ERROR TONE** on contents read out and display an "E". The PC programmer will be required to readout the radios frequency and tone programming.







- Normal radio operation resumes after the programming information has been displayed.

HOW TO FIELD PROGRAM FREQUENCY & TONE CODES

To match other radios, the owner can select Frequency, Tone and DQC Codes from [Table 1](#), [Table 2](#) and [Table 3](#) on pages 12 and 13. In our example, we will program an RQX-456 to operate on the "Brown Dot" frequency of 464.500 MHz with 100.0 Hz tone.







NOTES:

- Field programming frequency and tone codes will disable companding, disable any switch operation, disable Listen In, and remove all 2-Tone decode programming. If any of these operations are required they must be re-programmed after field programming of the frequency and tone codes.
- If the callbox has been PC programmed to a non-table frequencies it cannot be changed via field programming. You can, however, change the QC or DQC Tone Code via field programming by using the "No Change" Frequency Code "99" followed by the desired QC or DQC Tone Code.

04	1. Refer to Table 1 on page 12 to determine the two-digit frequency code and write it down.
12	2. Refer to Table 2 on page 13 to determine the two-digit tone code for 100.0 Hz and write it down.
	3. Loosen the (4) captive screws in the front corners of the case. These screws are captive to the housing; to prevent damaging them, DO NOT remove the screws from the housing.
	4. Separate the case front from the case back, leaving the batteries connected to the radio. Make sure the unit has batteries installed. NOTE: The voltage of the batteries must be greater than 6 VDC to program properly.
	5. Press and release the ON/PTT button on the front of the unit to turn the radio on.
	6. Press and HOLD the Program Button (See FIG-3 on page 6 for location). A "P" will appear on the program display as you enter program mode and the radio will beep rapidly.
	7. Release the program button after the beeping has stopped. The radio will emit a triple beep indicating that the radio is in program mode and a hyphen will appear on the program display.
<div style="display: flex; align-items: center;"> <div style="writing-mode: vertical-rl; transform: rotate(180deg); font-size: 8px; margin-right: 5px;">FREQUENCY CODE</div> <div style="margin-left: 5px;">  </div> </div>	8. Enter the 1 st digit of the frequency code by clicking the Program button until the program display shows the desired number. Pause—the radio will sound a low tone and show a hyphen across the center of the display to indicate that it is ready to accept the next digit.
<div style="display: flex; align-items: center;"> <div style="writing-mode: vertical-rl; transform: rotate(180deg); font-size: 8px; margin-right: 5px;">FREQUENCY CODE</div> <div style="margin-left: 5px;">  </div> </div>	9. Enter the 2 nd digit of the frequency code by clicking the Program button until the program display shows the desired number. Pause—the radio sounds a low tone and will show a hyphen across the center of the display to indicate that it is ready to accept the next digit.
<div style="display: flex; align-items: center;"> <div style="writing-mode: vertical-rl; transform: rotate(180deg); font-size: 8px; margin-right: 5px;">TONE CODE</div> <div style="margin-left: 5px;">  </div> </div>	10. Enter the 1 st digit of the tone code (or 1 st digit of the DQC code) by clicking the Program button until the program display shows the desired number. Pause—the radio sounds a low tone and will show a hyphen across the center of the display to indicate that it is ready to accept the next digit.
<div style="display: flex; align-items: center;"> <div style="writing-mode: vertical-rl; transform: rotate(180deg); font-size: 8px; margin-right: 5px;">TONE CODE</div> <div style="margin-left: 5px;">  </div> </div>	11. Enter the 2 nd digit of the tone code (or 2 nd digit of the DQC code) by clicking the Program button until the program display shows the desired number. Pause—the radio sounds a low tone and will show a hyphen across the center of the display to indicate that it is ready to accept the next digit.
	12. FOR DQC CODES ONLY – Enter the 3 rd digit of the DQC code by clicking the Program button until the program display shows the desired number. Pause—the radio sounds a low tone and will show a hyphen across the center of the display to indicate that it is ready to accept the next digit.
	13. Press and release the ON/PTT button to save your programming. A triple beep will sound to indicate that programming was successful and a hyphen will appear on the program display. The radio is now ready for another program entry.
	<p>NOTE: An error tone will sound if you attempt to save an incorrect code, an "E" will appear on the display. Check the digits you are attempting to enter, then re-enter.</p>
	14. Once you have made your final program entry, press the ON/PTT button a final time to turn the radio off. Turn the radio back on for normal operation.

HOW TO FIELD PROGRAM 2-TONE DECODE (RECEIVE) CODES

For special applications, it is desirable to program the Callbox for 2-Tone decode (receive) operation. The user is able to field program the radio for one of the 9 pre-determined tone pairs specified in **Table 4 on page 13**. These tone pairs correspond to field programmable 2-Tone encode (transmit) codes available in other RITRON portable and base radios. In our example we will program an RQX-456 to operate with 2-Tone Decode (Receive) Code 94 frequencies of 389.0 and 669.9 Hz.

- | | |
|--------------------------------------------------------------------------------------------------------------------------------------------------------------------------------------------------------------------------------------------------------------------------------------------------------------------------------------------------------------------------------------------------------------------------------|-----------------------------------------------------------------------------------------------------------------------------------------------------------------------------------------------------------------------------------------------------------------------------------------------------------------------------------------------------------------------------------------------------------------------------------------------------------------------------------------|
| 94 | <ol style="list-style-type: none"> Refer to Table 4 on page 13 to determine the two-digit code for 2-tone decode on 389.0 and 669.9 Hz and write it down. Loosen the (4) captive screws in the front corners of the case. These screws are captive to the housing; to prevent damaging them, DO NOT remove the screws from the housing. |
| | <ol style="list-style-type: none"> Separate the case front from the case back, leaving the batteries connected to the radio. Make sure the unit has batteries installed.
NOTE: The voltage of the batteries must be greater than 6 VDC to program properly. Press and release the ON/PTT button on the front of the unit to turn the radio on. |
|  | <ol style="list-style-type: none"> Press and HOLD the Program Button (See FIG-3 on page 6 for location). A "P" will appear on the program display as you enter program mode and the radio will beep rapidly. |
|  | <ol style="list-style-type: none"> Release the program button after the beeping has stopped. The radio will emit a triple beep indicating that the radio is in program mode and a hyphen will appear on the program display. |
| <div style="display: flex; align-items: center;"> <div style="writing-mode: vertical-rl; transform: rotate(180deg); font-size: small; margin-right: 5px;">2-TONE CODE</div> <div style="display: flex; flex-direction: column; gap: 5px;">   </div> </div> | <ol style="list-style-type: none"> Enter the 1st digit of the 2-Tone code by clicking the Program button until the program display shows the desired number. Pause—the radio will sound a low tone and show a hyphen across the center of the display to indicate that it is ready to accept the next digit. |
| <div style="display: flex; align-items: center;"> <div style="writing-mode: vertical-rl; transform: rotate(180deg); font-size: small; margin-right: 5px;">2-TONE CODE</div> <div style="display: flex; flex-direction: column; gap: 5px;">   </div> </div> | <ol style="list-style-type: none"> Enter the 2nd digit of the 2-Tone code by clicking the Program button until the program display shows the desired number. Pause—the radio sounds a low tone and will show a hyphen across the center of the display to indicate that it is ready to accept the next digit. |
|  | <ol style="list-style-type: none"> Press and release the ON/PTT button to save your programming. A triple beep will sound to indicate that programming was successful and a hyphen will appear on the program display. The radio is now ready for another program entry.

NOTE: An error tone will sound if you attempt to save an incorrect code, an "E" will appear on the display. Check the digits you are attempting to enter, then re-enter. |
| | <ol style="list-style-type: none"> Once you have made your final program entry, press the ON/PTT button a final time to turn the radio off. Turn the radio back on for normal operation. |

IMPORTANT NOTES:

- Field programming frequency and tone codes will remove all 2-Tone decode programming. If 2-Tone decode operation is required, the 2-Tone Decode Code must be re-programmed after field programming of the frequency and tone codes.
- When using 2-Tone decode for special applications (GateGuard® or Listen-In) the Feature Code must be entered first, followed by the 2-Tone Decode Code. Programming any of the Switch Operation, GateGuard® or Listen In features listed below requires re-programming of the 2-Tone Decode Code.
 - No Switch
 - Switch ON when called
 - Switch ON when active
 - GateGuard® momentary
 - GateGuard® toggle
 - Listen-In
- The radio can operate only one 2-Tone Decode function from the list above when field programmed. Your Ritron dealer can PC program the callbox to perform more than one 2-tone decode function. Contact your Ritron dealer for details.
- When the callbox is programmed for 2-Tone Decode operation, it is recommended that you do NOT use QC Tone Codes greater than "23" (146.2 Hz).

TABLE 1: PROGRAMMABLE FREQUENCY CODES.....

UHF Business Band				UHF Business Band				VHF Business Band			
Code	Frequency	ColorDot	BW	Code	Frequency	ColorDot	BW	Code	Frequency	ColorDot	BW
01	467.7625	J	25	40	461.2875		12.5	03	151.625	Red Dot	25
02	467.8125	K	25	41	461.3125		12.5	04	151.955	Purple Dot	25
03	464.5500	Yellow Dot	25	42	461.3375		12.5	05	151.925		25
04	464.5000	Brown Dot	25	43	461.3625		12.5	06	154.540		25
05	467.8500	Silver Star	25	44	462.7625		12.5	07	154.515		25
06	467.8750	Gold Star	25	45	462.7875		12.5	08	154.655		25
07	467.9000	Red Star	25	46	462.8125		12.5	09	151.685		25
08	467.9250	Blue Star	25	47	462.8375		12.5	10	151.715		25
09	469.2625		25	48	462.8625		12.5	11	151.775		25
10	462.5750	White Dot	25	49	462.8875		12.5	12	151.805		25
11	462.6250	Black Dot	25	50	462.9125		12.5	13	151.835		25
12	462.6750	Orange Dot	25	51	464.4875		12.5	14	151.895		25
13	464.3250		25	52	464.5125		12.5	15	154.490		25
14	464.8250		25	53	464.5375		12.5	16	151.655		25
15	469.5000		25	54	464.5625		12.5	17	151.745		25
16	469.5500		25	55	466.0375		12.5	18	151.865		25
17	463.2625		25	56	466.0625		12.5	24	151.700		12.5
18	464.9125		25	57	466.0875		12.5	25	151.760		12.5
19	464.6000		25	58	466.1125		12.5	26	152.700		25
20	464.7000		25	59	466.1375		12.5	99	No change		---
21	462.7250		25	60	466.1625		12.5				
22	464.5000		12.5	61	466.1875		12.5				
23	464.5500		12.5	62	466.2125		12.5				
24	467.7625		12.5	63	466.2375		12.5				
25	467.8125		12.5	64	466.2625		12.5				
26	467.8500		12.5	65	466.2875		12.5				
27	467.8750		12.5	66	466.3125		12.5				
28	467.9000		12.5	67	466.3375		12.5				
29	467.9250		12.5	68	466.3625		12.5				
30	461.0375		12.5	69	467.7875		12.5				
31	461.0625		12.5	70	467.8375		12.5				
32	461.0875		12.5	71	467.8625		12.5				
33	461.1125		12.5	72	467.8875		12.5				
34	461.1375		12.5	73	467.9125		12.5				
35	461.1625		12.5	74	469.4875		12.5				
36	461.1875		12.5	75	469.5125		12.5				
37	461.2125		12.5	76	469.5375		12.5				
38	461.2375		12.5	77	469.5625		12.5				
39	461.2625		12.5	99	No change		---				

VHF MURS**			
Code	Frequency	ColorDot	BW
01	154.600	Green Dot	25
02	154.570	Blue Dot	25
19	151.820	MURS	12.5
20	151.880	MURS	12.5
21	151.940	MURS	12.5
22	154.600	MURS	12.5
23	154.570	MURS	12.5

Notes			
** MURS frequencies do not require an FCC license. All other frequencies require an FCC license.			
• BW is the bandwidth in kHz.			
• 12.5 kHz indicates a narrow band channel, 25 kHz indicates a wide band channel.			

Note: If the callbox has been PC programmed to a non-table frequencies it cannot be changed via field programming. You can, however, change the QC or DQC Tone Code via field programming by using the “No Change” Frequency Code “99” followed by the desired QC or DQC Tone Code.

CANADIAN FREQUENCY CODES.....

Canada Models UHF Business Band				Canada Models VHF Business Band				British Columbia Models VHF Business Band			
Code	Frequency	ColorDot	BW	Code	Frequency	ColorDot	BW	Code	Frequency	ColorDot	BW
01	458.6625		25	01	151.055		25	01	154.100		25
02	469.2625		25	02	151.115		25	02	158.940		25

TABLE 2: INTERFERENCE ELIMINATOR PROGRAMMABLE QC TONE CODES

Code	Frequency	Code	Frequency	Code	Frequency	Code	Frequency
01	67.0	14	107.2	27	167.9	40	159.8
02	71.9	15	110.9	28	173.8	41	165.5
03	74.4	16	114.8	29	179.9	42	171.3
04	77.0	17	118.8	30	186.2	43	177.3
05	79.7	18	123.0	31	192.8	44	No Tone
06	82.5	19	127.3	32	203.5	45	183.5
07	85.4	20	131.8	33	210.7	46	189.9
08	88.5	21	136.5	34	218.1	47	196.6
09	91.5	22	141.3	35	225.7	48	199.5
10	94.8	23	146.2	36	233.6	49	206.5
11	97.4	24	151.4	37	241.8	50	229.1
12	100.0	25	156.7	38	250.3	51	254.1
13	103.5	26	162.2	39	69.4	00	No Tone

TABLE 3: DIGITAL INTERFERENCE ELIMINATOR PROGRAMMABLE DQC TONE CODES

Code	Code	Code	Code	Code	Code	Code	Code
023	072	152	244	311	412	466	631
025	073	155	245	315	413	503	632
026	074	156	246	325	423	506	645
031	114	162	251	331	431	516	654
032	115	165	252	332	432	523	664
036	116	172	255	343	445	532	703
043	122	174	261	346	446	546	712
047	125	205	263	351	452	565	723
051	131	212	265	356	454	606	731
053	132	223	266	364	455	662	732
054	134	225	271	365	462	612	734
065	143	226	274	371	464	624	743
071	145	243	306	411	465	627	754

TABLE 4: PROGRAMMABLE 2-TONE DECODE (RECEIVE) CODE.....

Code	Tone 1	Tone 2
90	*	*
91	330.5	569.1
92	349.0	600.9
93	368.5	634.5
94	389.0	669.9
95	410.8	707.3
96	433.7	746.8
97	457.9	788.5
98	483.5	832.5
99	330.5	600.9





NOTES:

1. 2-Tone Decode codes 91-99 operate with Ring Tone and Transpond enabled. See "2-TONE DECODE (RECEIVE) SETTINGS" section on page 21 for a full description of these features.
 2. When the callbox is programmed for 2-Tone Decode operation, it is recommended that you do NOT use QC Tone Codes greater than "23" (146.2 Hz).
- * If the Callbox displays 2-Tone Code "90" on readout it has been PC programmed for custom frequencies.

HOW TO FIELD PROGRAM SINGLE-DIGIT RADIO FEATURE CODES

The OUTPOST® Callbox can be field programmed for a specific number of features that include companding, GateGuard®, Call Tone, and speaker volume level. Refer to **Table 5 below** for the single digit codes available for field programming. In our example we will program an RQX-456 for Call Tone operation.

NOTE: Field programming frequency and tone codes will turn companding and GateGuard® **OFF**. If companding or GateGuard® operation is required, the single-digit Radio Feature code must be re-programmed after field programming of the frequency and tone codes.

- 9
 1. Refer to [Table 5](#) below to determine the single-digit code used to enable Call Tone.
 2. Loosen the (4) captive screws in the front corners of the case. These screws are captive to the housing; to prevent damaging them, **DO NOT** remove the screws from the housing.
 3. Separate the case front from the case back, leaving the batteries connected to the radio. Make sure the unit has batteries installed.
NOTE: The voltage of the batteries must be greater than 6 VDC to program properly.
 4. Press and release the **ON/PTT** button on the front of the unit to turn the radio on.
 -  5. Press and **HOLD** the Program Button (See FIG-3 on page 6 for location). A "P" will appear on the program display as you enter program mode and the radio will beep rapidly.
 -  6. Release the program button after the beeping has stopped. The radio will emit a triple beep indicating that the radio is in program mode and a hyphen will appear on the program display.
 -   7. Enter the single-digit code by clicking the Program button until the program display shows the desired number. Pause—the radio will sound a low tone and show a hyphen across the center of the display to indicate that it is ready to accept the next digit.
 8. Press and release the **ON/PTT** button to save your programming. A triple beep will sound to indicate that programming was successful and a hyphen will appear on the program display. The radio is now ready for another program entry.

NOTE: An error tone will sound if you attempt to save an incorrect code, an "E" will appear on the display. Check the digits you are attempting to enter, then re-enter.
 -  9. Once you have made your final program entry, press the **ON/PTT** button a final time to turn the radio off. Turn the radio back on for normal operation.

TABLE 5: SINGLE DIGIT RADIO FEATURE CODES

Code	Feature	Default	Description
1	Companding ON		Companding will compress transmit audio before sending it, and expand receive audio before it is heard on the speaker to reduce the background noise common in radio communications. Companding is not recommended unless all radios in the system are companded.
2	Companding OFF	√	
3	Volume Level – Medium	√	Sets Volume level to 50%
4	Volume Level – High		Sets Volume level to 100%
5	GateGuard® ON		Provides momentary (1 second) switch closure via on-board relay. The 2-Tone Decode code must be programmed AFTER entering the GateGuard® ON code.
6	GateGuard® OFF	√	The GateGuard® OFF code will disable the 2-Tone Decode Code.
7	Transmit Low Pwr (1 W)	√	
8	Transmit High Pwr (2 W)		UHF Model Only: Refer to Special Notice on page 4 regarding Alkaline Battery usage.
9	Call Tone ON	√	When PTT button is initially pressed a Call Tone will be transmitted.
0	Call Tone OFF		

√ = The Callbox is set from the factory with these options **enabled**.

HOW TO FIELD PROGRAM ADVANCED FEATURE CODES

The OUTPOST® Callbox can be field programmed for a number of advanced features. Refer to **Table 6** for the three digit codes available for field programming. In our example we will program an RQX-456 for an RQX Reset Time of 30 seconds.

1. Refer to [Table 6](#) to determine the three-digit feature code and write it down.
 2. Loosen the (4) captive screws in the front corners of the case. These screws are captive to the housing; to prevent damaging them, **DO NOT** remove the screws from the housing.
 3. Separate the case front from the case back, leaving the batteries connected to the radio. Make sure the unit has batteries installed.
NOTE: The voltage of the batteries must be greater than 6 VDC to program properly.
 4. Press and release the **ON/PTT** button on the front of the unit to turn the radio on.
 5. Press and **HOLD** the Program Button (See FIG-3 on page 6 for location). A "P" will appear on the program display as you enter program mode and the radio will beep rapidly.
 6. Release the program button after the beeping has stopped. The radio will emit a triple beep indicating that the radio is in program mode and a hyphen will appear on the program display.
 7. Enter the 1st digit of the feature code by clicking the Program button until the program display shows the desired number. Pause—the radio will sound a low tone and show a hyphen across the center of the display to indicate that it is ready to accept the next digit.
 8. Enter the 2nd digit of the feature code by clicking the Program button until the program display shows the desired number. Pause—the radio sounds a low tone and will show a hyphen across the center of the display to indicate that it is ready to accept the next digit.
 9. Enter the 3rd digit of the feature code by clicking the Program button until the program display shows the desired number. Pause—the radio sounds a low tone and will show a hyphen across the center of the display to indicate that it is ready to accept the next digit.
 10. Press and release the **ON/PTT** button to save your programming. A triple beep will sound to indicate that programming was successful and a hyphen will appear on the program display. The radio is now ready for another program entry.
- NOTE:** An error tone will sound if you attempt to save an incorrect code, an "E" will appear on the display. Check the digits you are attempting to enter, then re-enter.
11. Once you have made your final program entry, press the **ON/PTT** button a final time to turn the radio off. Turn the radio back on for normal operation.

TABLE 6: ADVANCED FEATURE CODES

Code	Feature	Default	Description
RQX Reset Time			
801	5 seconds		RQX Reset Time is the length of time the RQX Callbox can remain inactive (not receiving or transmitting) before it automatically shuts off.
802	10 seconds	√	
803	20 seconds		
804	30 seconds		
805	45 seconds		
806	1 minute		
807	2 minutes		
808	3 minutes		
809	4 minutes		

√ = The Callbox is set from the factory with these options **enabled**.

TABLE 6: ADVANCED FEATURE CODES (CONTINUED)

Code	Feature	Default	Description
Switch Operation			
811	No Switch *	√	Disables 2-Tone decode and all switch operation.
812	Switch On When Called		Switch closes (e.g. strobe light turns on) when Callbox 1 st receives a call. Switch opens (e.g. strobe light turns off) as soon as the PTT is pressed. Enabling this feature will disable 2-Tone decode.
813	Switch On When Active		Switch is closed (e.g. strobe light turns on) as long as Callbox is in use. Switch opens (e.g. strobe light turns off) when Callbox has not been used (transmit or receive) for a period of time longer than RQX Reset Time. Enabling this feature will disable 2-Tone decode.
814	GateGuard® Momentary *		Switch is closed for 1 second when correct 2-Tone Decode Code is received. Enabling this feature will disable any previously programmed 2-Tone decode operation and require re-entry of the 2-Tone Decode Code before it can operate.
815	GateGuard® Toggle		Switch alternately closes and opens when correct 2-Tone Decode Code is received. Enabling this feature will disable any previously programmed 2-Tone decode operation and require re-entry of the 2-Tone Decode Code before it can operate.
Special Features			
821	Reset to Factory Defaults		Resets Callbox to Factory default programming.
822	Display Radio Revision		Callbox will display a sequence of 6 digits to identify operating code revision. This is helpful when troubleshooting the radio.
823	Enable External +12 VDC		Enables the External +12 VDC "Loss of power" notification feature.
824	Disable External +12 VDC	√	Disables the External +12 VDC "Loss of power" notification and reverts back to "Low Battery" notification.
825	Enable Auto Turn-Off	√	Callbox will automatically turn off when it has not been used (transmit or receive) for a period of time longer than the RQX Reset Time.
826	Disable Auto Turn-Off		Callbox will remain on at all times. This mode of operation is not recommended for battery-powered applications.
827	Enable Busy Channel TX Inhibit		Callbox cannot transmit when there is a received signal. A "busy signal" will be heard on the Callbox speaker when the PTT is pressed and a received signal is present.
828	Disable Busy Channel TX Inhibit	√	Callbox will transmit whenever the PTT is pressed, regardless of any received signal.
829	Mic Gain High		Places the microphone into high gain operation where quiet and distant voices will be heard. This mode of operation will increase background noise transmitted by the Callbox.
820	Mic Gain Normal	√	Places the microphone into normal gain operation for the majority of applications where the user is talking directly into the Callbox. This mode of operation will decrease background noise transmitted by the Callbox.
Listen In Time			
870	Listen In Off	√	The Callbox will automatically transmit for a period of time equal to the Listen In Time when the correct 2-Tone decode code is received.
871	Listen In 5 seconds		
872	Listen In 10 seconds		
873	Listen In 20 seconds		
874	Listen In 30 seconds		
Receive Volume Level			
875	10%		Sets the speaker volume level of received signals.
876	25%		
877	50% *	√	
878	75%		
879	100% *		

√ = The Callbox is set from the factory with these options **enabled**.
 * Setting is also available via Single-Digit Radio Feature Code programming.

PROGRAMMABLE OUTPOST® CALLBOX FEATURES

The OUTPOST® Callbox has a variety of programmable features that determine how your callbox operates. Some of these features can be Field Programmed (FP) by you **without** using special tools, while other features can only be Programmed (PC) with a PC and RQX Series PC Programmer version 10.1.0 or higher. Contact your Ritron dealer or the factory for details.

Glossary of Terms

Intercom Mode – The Automatic Turn-Off feature has been disabled and the Callbox is able to receive calls at any time.

Sleep – If Automatic Turn-Off is **DISABLED** and Battery Saver is **ENABLED** the Callbox will go into a low current Sleep Time when it is not being used, waking up periodically to check for a received message. Pressing the **ON/PTT** button will wake-up the radio immediately.

Wake-Up – When Battery Saver is **ENABLED** and the Callbox has entered the low current Sleep state, the radio will wake-up periodically to check for a received message. The Sleep Time is set by the Battery Saver Sleep Time.

No Activity Time – A continuous period of time where the Callbox is not sending or receiving a call.

Programmable Features Key:

FP for Field Programmable Feature – no software required

PC for PC Programmable Feature with Software

Field Programming Enable (PC)

This option is **ENABLED** as the Factory Default setting. This permits all Field Programmable features (FP) to be field programmed by you. If **DISABLED**, the features can only be programmed using special Ritron PC Programming software.

Send Call Tone (PC or FP)

The Factory Default setting has the Call Tone feature **ON** (refer to “How to Field Program Single-Digit Radio Feature Codes on page 14). The callbox can be programmed to transmit a Call Tone if the Reset Time has expired and the **ON/PTT** button is pressed. This will alert system users that the call is originating from the callbox.

Speaker Volume..... (PC or FP)

The Factory Default setting is medium volume. Field programming allows you to select from 5 different Volume settings. PC Programming allows any volume level between 2 – 100%. A lower speaker volume reduces audio distortion and provides a more natural sound. For best performance, do not set the volume any higher than is necessary for your application.

Companding (PC or FP)

The Factory Default setting for Companding is **OFF (NOT selected)**. The radio can be programmed to **ENABLE or DISABLE** audio companding. Companding will compress transmit audio before sending it, and expand receive audio before it is heard on the speaker to reduce the background noise common in radio communications. See page 14.

High/Low Power (PC or FP)

The UHF callbox can be set to transmit at high (2-Watt) or low (1-Watt) power. Low power is recommended in battery powered installations.



Refer to Special Note on page 4 regarding **Alkaline** batteries.

Automatic Turn-Off (PC or FP)

This feature is **ENABLED** as the Factory Default setting. The callbox will turn **OFF** when the RQX Reset Time has expired. The Reset Time is a pre-programmed amount of time of “no activity” (no calls transmitted, no calls received) before the callbox turns **OFF** in order to conserve battery life. The callbox can be turned back **ON** when the **ON/PTT** button is pressed. This is the recommended mode of operation for all battery only powered applications.

If Automatic Turn-OFF is **NOT** selected the callbox does **NOT** completely turn **OFF**, but remains in the Intercom mode, allowing the callbox to receive calls at any time.

Operating the callbox with Automatic Turn-OFF **DISABLED** significantly increases battery drain, and is therefore **NOT** recommended for battery only powered applications. Battery life can be increased using the Battery Saver Enable feature detailed in this section.

Battery Saver Enable..... (PC)

When the OUTPOST® Callbox is programmed to operate with Automatic Turn-Off disabled, Battery Saver can increase battery life in both internal and external battery powered applications.

With Battery Saver Enable, the callbox will periodically Wake-Up and listen for a received signal before returning to a low current Sleep state. The time between Wake-Up states can be PC programmed between 0.5 - 8 seconds with the Battery Saver Sleep Time setting. A longer time between Wake-Up states will result in increased battery life.

The callbox immediately leaves Battery Saver mode any time the **ON/PTT** Button is pressed or a signal is received, and will not return to Battery Saver until the period of no activity exceeds the RQX Reset Time.

PROGRAMMABLE OUTPOST® CALLBOX® FEATURES (CONTINUED)

External +12 VDC Power Fail Alert Tone (PC or FP)

By selecting the +12 VDC Power Fail Alert Tone feature the callbox will look for a loss of the +12 VDC power source. The callbox will immediately transmit an Alert Tone to notify personnel that the +12 VDC source has been lost and is now operating on battery back-up. The callbox will transmit an Alert Tone once every hour until the +12 VDC power source is restored or until the back-up batteries are exhausted. Even if this feature is **NOT** selected, it will always revert to Back-up Battery power, see page 4 for details.

RQX Reset Time (PC or FP)

Set from the factory for 10 seconds, the RQX Reset Time can be Field Programmed to 9 different times ranging from 5 seconds to 4 minutes, and PC programmed for 5-255 seconds. A shorter RQX Reset Time will result in increased battery life. In standard Automatic Turn-Off operation a longer RQX Reset Time will allow more time for a response before the Callbox turns off.

RQX Reset Time defines the Inactivity Time allowed before the Callbox:

- Turns Off if Automatic Turn-Off is ENABLED.
- Enters Battery Saver mode if Battery Saver is ENABLED.
- Resets 2-Tone Paging Decode.
- Automatically opens the Switch output.

Microphone Gain (PC or FP)

The Microphone can be placed in HIGH or NORMAL gain mode. With the microphone in high gain mode quiet and distant voices will be heard. This mode of operation will increase background noise transmitted by the Callbox.

The Microphone gain is set to NORMAL mode by default. Leave the microphone in normal gain mode for the majority of applications where the user is talking directly into the Callbox. This mode of operation will decrease background noise transmitted by the Callbox.

Listen In (PC or FP)

Listen In allows remote activation of the Callbox transmitter for a programmed period of time when the correct 2-Tone code is decoded.

This feature, turned **OFF** by default, can be Field Programmed to 4 different transmit times ranging from 5-30 seconds and PC programmed for 1-255 seconds.

The 2-Tone Decode Code required to activate the feature can be Field Programmed from the 9 different 2-Tone Decode Codes in Table 4, or PC programmed for any 2-Tone frequency pair between 300-1500 Hz.

Busy Channel TX Inhibit..... (PC or FP)

With this feature enabled the Callbox cannot transmit when there is a received signal. A “busy signal” will be heard on the Callbox speaker when the PTT is pressed and a received signal is present. Busy Channel TX Inhibit is disabled from the factory.

Sensor/Contact Closure Input.....

The Callbox will send a warning tone when a change in the Sensor Input is detected. The Sensor Input will respond to an **OPEN** or **CLOSED** switch.

Transmit Beep Enable (PC)

This feature is turned on from the factory to provide a short beep in the Callbox speaker any time the **ON/PTT** button is pressed. This assures the Callbox user that the radio has turned on and is ready to transmit their message. With this feature disabled the Callbox will only beep when the radio is first turned on.

RX Courtesy Beep Enable..... (PC)

In high noise environments it is sometimes difficult to determine when a received message has ended. With the RX Courtesy Beep enabled the Callbox will sound a short beep on the speaker at the end of each received transmission.

Narrow or Wide Band Operation..... (PC)

A number of table frequencies, which are Field Programmable, offer you a choice between narrow (12.5 kHz) or wide (25 kHz) band operation. See “TABLE 1: PROGRAMMABLE FREQUENCY CODES” on page 12. The callbox automatically makes the narrow or wide band adjustment depending on the frequency code selected.

The callbox can be PC programmed with Ritron RQX software to operate either narrow or wide band on any custom frequency within the specified band.

TX Time Out Time (PC)

Set from the factory for 60 seconds, the TX Time Out Time can be programmed for 1-255 seconds. This sets the length of time the Callbox can transmit continuously. If the **ON/PTT** button is held down longer than the TX Time Out Time will allow, the radio will stop transmitting and a “Busy Signal” will be heard in the speaker until the button is released.

DTMF or Selcall ANI..... (PC)

The RQX can be programmed to send a 1-9 digit DTMF or 3-7 digit Selcall ANI code at the beginning of each transmission for radio identification.

INTERCOM (ALWAYS ON) PROGRAMMING

The OUTPOST® can be Field or PC programmed by the factory or by your Ritron dealer to operate as a two-way intercom. When operating as an intercom the Automatic Turn-Off must be **DISABLED** so that the radio will remain **ON** in a “intercom” mode. The callbox can receive a call from another radio at any time. The higher current requirements of Intercom operation make it undesirable in battery powered only installations. It is recommended that you power the callbox using +12 VDC capability. See page 4.

Required Radio Programming:

Automatic Turn-Off..... (PC or FP)

This feature must be **DISABLED** via Field or PC programming for the callbox to remain **ON** at all times.

Other Programmable Features to Consider:

Battery Saver (PC)

Battery Saver can be used to increase battery life in battery powered applications. With Battery Saver enabled, the callbox will periodically “wake-up” and listen for a received signal before returning to a low current “sleep” mode. The Sleep Time can be PC programmed between 0.5 - 8 seconds. A longer sleep time will result in increased battery life, but may result in missed calls.

Busy Channel TX Inhibit(PC or FP)

If **ENABLED** this feature prevents you from talking over someone else on the same channel even if they are using a different tone code. The radio will beep a series of long, low tones that sounds like a “busy signal” when you press the **ON/PTT** button.

USEFUL FEATURES TO USE WITH INTERCOM (ALWAYS ON) PROGRAMMING

Programming for Selective Calling:

2-Tone Paging Decode.....(PC or FP)

This allows selective calling to a Callbox in a radio system where there is more than one Callbox. When the Callbox is programmed for 2-tone decode in Intercom (Always-On) mode it will sound an alert tone on the Callbox speaker, similar to a telephone ring tone, whenever 2-tone page has been successfully decoded. This will alert any users in the immediate area that there is an incoming call on the Callbox.

Ring Tone..... (PC)

Ring Tone must be set to sound the alert tone on the Callbox speaker when a 2-Tone Page is successfully decoded. Ring Tone is enabled from the factory.

2-Tone Monitor Trip..... (PC)

This can be set when used with 2-Tone decode to allow the Callbox to hear all radio traffic on the channel after it has successfully decoded the correct 2-tone code, regardless of QC or DQC programming.

- Normal conversation will follow after the 2-tone code is decoded.
- If the **ON/PTT** button is pressed the Callbox returns to QC or DQC decode operation.
- The radio will automatically reset back to 2-tone decode after the RQX Reset Time has expired.

Switch Output Programming:

Switch on When Called(PC or FP)

This will close the internal Switch Output whenever the radio receives a call after an Inactivity Time that exceeds the RQX Reset Time. The switch will remain closed until the **ON/PTT** button is pressed or the RQX Reset Time expires. The Switch Output could be used to turn on a light or activate an alarm to notify users in the area that an incoming call was present.

SWITCH OUTPUT OPTIONS –ALLOWS CONTROL OF AN EXTERNAL DEVICE

(e.g., a gate controller, a strobe light, or any relay controlled device.)

The switch output is a simple 1-Amp relay contact closure that can be used to **OPEN** and **CLOSE** a gate, switch on a light, sound an alarm or any other application where remote control of an ON/OFF switch is required. The OUTPOST® Callbox can be programmed to **OPEN** and **CLOSE** the Switch Output when one of the following programmed conditions is met.

The Callbox can be programmed to alternately **OPEN** and **CLOSE** the switch using a single 2-tone code, or can be PC programmed for separate **OPEN** and **CLOSE** 2-tone codes. Field programming offers nine 2-tone codes that correspond to field programmable 2-tone codes available in select RITRON portable and base radios.

No Switch (PC or FP)

Select this option for no switch operation.

Switch On When Called..... (PC or FP)

With this option selected the switch will **CLOSE** when the Callbox first receives a call. The switch will remain **CLOSED** until the **ON/PTT** button is pressed or the RQX Reset Time expires. This option is not applicable if the Callbox is programmed for Automatic Turn-Off.

Switch On When Callbox in Use..... (PC or FP)

This option will **CLOSE** the switch when the Callbox first sends or receives a call. The switch will remain closed until the RQX Reset Time expires, which also turns the radio off if it is programmed for Automatic Turn-Off.

Switch On When Active with Turn-Off Code (PC)

This option operates the same as Switch On When Callbox in Use with the added ability to **OPEN** the switch when a unique 2-Tone Turn-Off Code is received. Unlike the Switch On When Callbox in Use feature, the switch will not **OPEN** when the RQX Reset Time expires unless the Callbox is programmed for Automatic Turn-Off. See "2-TONE DECODE (RECEIVE) SETTINGS" on page 21 for details on programming a 2-Tone Turn-Off code.

GateGuard® – Momentary for 1 sec.

..... (PC or FP)

With this option selected the switch will momentarily **CLOSE** when a unique 2-Tone code is received. The switch will remain **CLOSED** for the programmed period of time, programmable for 1-255 seconds. See "2-TONE DECODE (RECEIVE) SETTINGS" on page 21 for details on programming a 2-Tone Decode Code. Single-Digit field programming the Callbox for GateGuard® operation places the radio into this momentary mode.

GateGuard® – Toggle..... (PC or FP)

With this option selected the switch will alternately **OPEN** and **CLOSE** when it receives a unique 2-Tone code. After the 2-tone code is received the Callbox will transmit a **SINGLE BEEP** if the switch has been **OPENED** and a **DOUBLE BEEP** if the switch has been **CLOSED**. The switch will open when the Callbox turns off if it is programmed for Automatic Turn-Off. See "2-TONE DECODE (RECEIVE) SETTINGS" on page 21 for details on programming a 2-Tone Decode Code.

GateGuard® – On Code / Off Code (PC)

When this option is selected the switch will **CLOSE** when a unique 2-Tone code is received, and **OPEN** when the 2-Tone Turn-Off code is received. The switch will **OPEN** when the Callbox turns off if it is programmed for Automatic Turn-Off. See "2-TONE DECODE (RECEIVE) SETTINGS" on page 21 for details on programming a 2-Tone Decode Code and a 2-Tone Turn-Off Code.

2-TONE DECODE (RECEIVE) SETTINGS

2-Tone decode can be used to selectively call the Callbox in a system where multiple radios operate on a single frequency. Alternatively, 2-Tone decode can also be used to operate the Switch Output built into every Callbox.

When the radio is programmed for 2-Tone Paging decode, no call will be heard unless the 2-tone code has been successfully decoded or the **ON/PTT** button has been pressed. After decoding, normal 2-way conversation is possible without the need for the 2-tone code. 2-Tone Paging Decode is automatically reset when the RQX Reset Time expires.

When the Callbox is programmed for Switch Output or Listen In operation with 2-Tone decode, regular voice communication is unaffected by the 2-tone code. If a Switch Output Option is selected that uses 2-tone decode it cannot be used for 2-Tone Paging Decode.

NOTICE

When the callbox is programmed for 2-Tone Decode operation, it is recommended that you do NOT use QC Tone Codes greater than "23" (146.2 Hz).

2-Tone Table #..... (PC or FP)

The OUTPOST® Callbox comes equipped with 9 pre-determined 2-Tone codes that correspond to table codes that certain RITRON portable and base radios can send. Use of the 2-Tone Table codes allows programming without the need for the PC programmer.

1st Tone decoded for **1** sec. (PC)

You can custom program the 1st tone of the 2-tone code to any frequency between 300-1500 Hz. The 1st tone must be decoded for the programmed period of time before the radio looks for the 2nd tone. The factory setting for decode time is 1 second.

2nd Tone decoded for **1** sec. (PC)

You can custom program the 2nd tone of the 2-tone code to any frequency between 300-1500 Hz. The 2nd tone must be decoded for the programmed period of time after the 1st tone has been decoded. The factory setting for decode time is 1 second.

All Call decoded for **4** sec. (PC)

With 2-Tone All Call enabled you can custom program an All Call tone to any frequency between 300-1500 Hz. The All Call tone must be decoded for the programmed period of time. All Call is not enabled as received from the factory.

Ring Tone Enable.....(PC)

With this feature enabled the Callbox will sound a ring signal in the speaker, similar to a telephone ring, any time the 2-Tone code, Group Call or All Call code is decoded. Ring Tone is enabled from the factory.

2-Tone Transpond(PC)

2-Tone Transpond transmits a tone after the 2-Tone code, Group Call or All Call code has been received to alert the calling radio that the 2-Tone code was successfully decoded. 2-Tone Transpond is enabled from the factory.

2-Tone Group Call.....(PC)

When this option is set, 2-tone decode is achieved if the radio receives the 1st tone for the programmed All Call time. If this option is selected the All Call time must be longer than the 1st Tone time or the Callbox will always decode on the 1st tone, ignoring the 2nd tone altogether. Group Call is not enabled as received from the factory.

2-Tone Monitor Trip(PC)

With this option selected the Callbox will be in carrier squelch mode any time the 2-Tone code is decoded, regardless of any QC or DQC code programmed in the radio. The radio reverts back to QC or DQC tone decode if the **ON/PTT** button is pressed and reverts back to 2-tone decode after the RQX Reset Time has expired. 2-Tone Monitor Trip is not enabled from the factory.

2-Tone Decode with Subtone(PC)

With 2-Tone Decode with Subtone enabled, the Callbox will not decode 2-Tone codes unless the correct subtone is also present. 2-Tone Decode with Subtone is not enabled from the factory.

Turn-Off Code.....(PC)

In certain Switch Output applications a separate 2-Tone Turn-Off Code is required. This code can not be the same as the 2-Tone Decode Code.

Listen In Ring Tone Enable.....(PC)

With this feature enabled the Callbox will sound a ring signal in the speaker, similar to a telephone ring, any time the 2-Tone Listen In code is decoded. Listen In Ring Tone is not enabled from the factory.

CONFIGURING THE CALLBOX FOR A GATEGUARD® APPLICATION....

The XT OUTPOST® can be mounted to virtually any surface with four (4) ¼" panhead screws. Choose a type of screw thread and screw length which will hold firmly in the surface to which the unit will be mounted.

MOUNTING the XT OUTPOST®: (Refer to FIG-6)

1. Remove the front faceplate from the XT Callbox. The faceplate is secured to the case with 4 vandal-resistant buttonhead, Torx screws. Use the T-25 Torx bit included with the radio to remove these screws.

2. Remove the "Mounting Bracket" kit secured to the inside of the XT Callbox case.

3.  Due to the wide variety of installation possibilities, RITRON does not provide the cables or hardware required to bring external connections into the XT Callbox.

- When selecting your cable hardware be sure it will adequately seal the cable to the case.
- Carefully study the internal construction of the XT Callbox and determine the location on the outside case where the external supply and GateGuard® hook-up will be brought in.
- Consider clearance with your desired hardware.

4. Remove the 4 flathead screws securing the internal mounting plate and remove entire internal case assembly. The front faceplate will be attached to the internal case assembly, handle with care.
5. Carefully drill the hole in the XT Callbox case required for your external hook-up cable installation.
6. Install the 4 mounting brackets to the back of the XT Callbox case shown in FIG-4 on page 7. The mounting brackets can be installed vertically, as shown, or horizontally.

7. CONNECTING THE SWITCH OUTPUTS TO AN EXTERNAL DEVICE

- a. Thread your external hookup cable from the external device you wish to control through the hole with approximately 6 inches of cable inside the XT case.
- b. Your external cable will be connected to the XT Callbox 6-conductor interface cable with wirenuts, dress your external wires accordingly (Refer to Table 7 on page 23).
- c. With your selected hardware, secure and seal the conduit to ensure moisture and vandal resistant functions to the XT Callbox case.

- Consult the manufacturer of the external device you are attempting to control for the recommended wire gauge.
- Confirm that your application will NOT exceed the maximum rating of the on-board relay of 120 VAC @ 1 amp.
- Make sure all power to the equipment is turned OFF or disconnected.

8.  **CAUTION:** The interface cable and wirenuts should be positioned on the right side of the case, opposite the antenna (See FIG-6 on page 23)

8. Position the XT Callbox case in the chosen installation location and secure it in place with four screws through the mounting brackets.
9. If programming is required, loosen the (4) captive screws in the front corners of the internal Callbox case and separate the case front from the case back. These screws are captive to the housing; to prevent damaging them, DO NOT remove the screws from the housing.
10. Program the radio, if required. Refer to the programming section of this manual for details. To program the radio you must first apply +12 VDC external power, or alkaline batteries.

11. If rechargeable NiCd batteries are used for battery backup the "Charge Jumper" must be placed into the "charge" position as shown below.

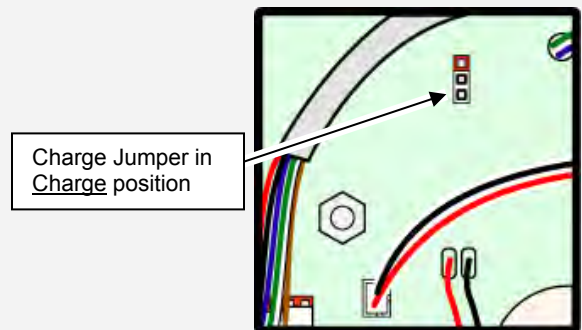

!! CAUTION !!

If rechargeable batteries are NOT used for battery backup, be sure the "Charge Jumper" is NOT in the "charge position. Charging alkaline batteries will damage the cells and reduce battery life!

12. Fasten the internal case front to the case back with the four (4) captive screws. Do not over-tighten the plastic screws to prevent damage.

13. Secure the internal case assembly to the XT Callbox with the 4 flathead screws through the internal mounting plate. Refer to FIG-6 for correct orientation and location of the antenna and cables. The front faceplate is attached to the internal case assembly, handle with care.

14. Re-fasten the front faceplate to the radio with the 4 buttonhead Torx screws.

Be sure both the interface cable and the front-panel On/PTT switch cable are routed to the side of the internal plastic case assembly, away from the antenna. The cables cannot lay across the face of the internal plastic case, they must be alongside.

FIG: 6 XT CALLBOX ASSEMBLY.....

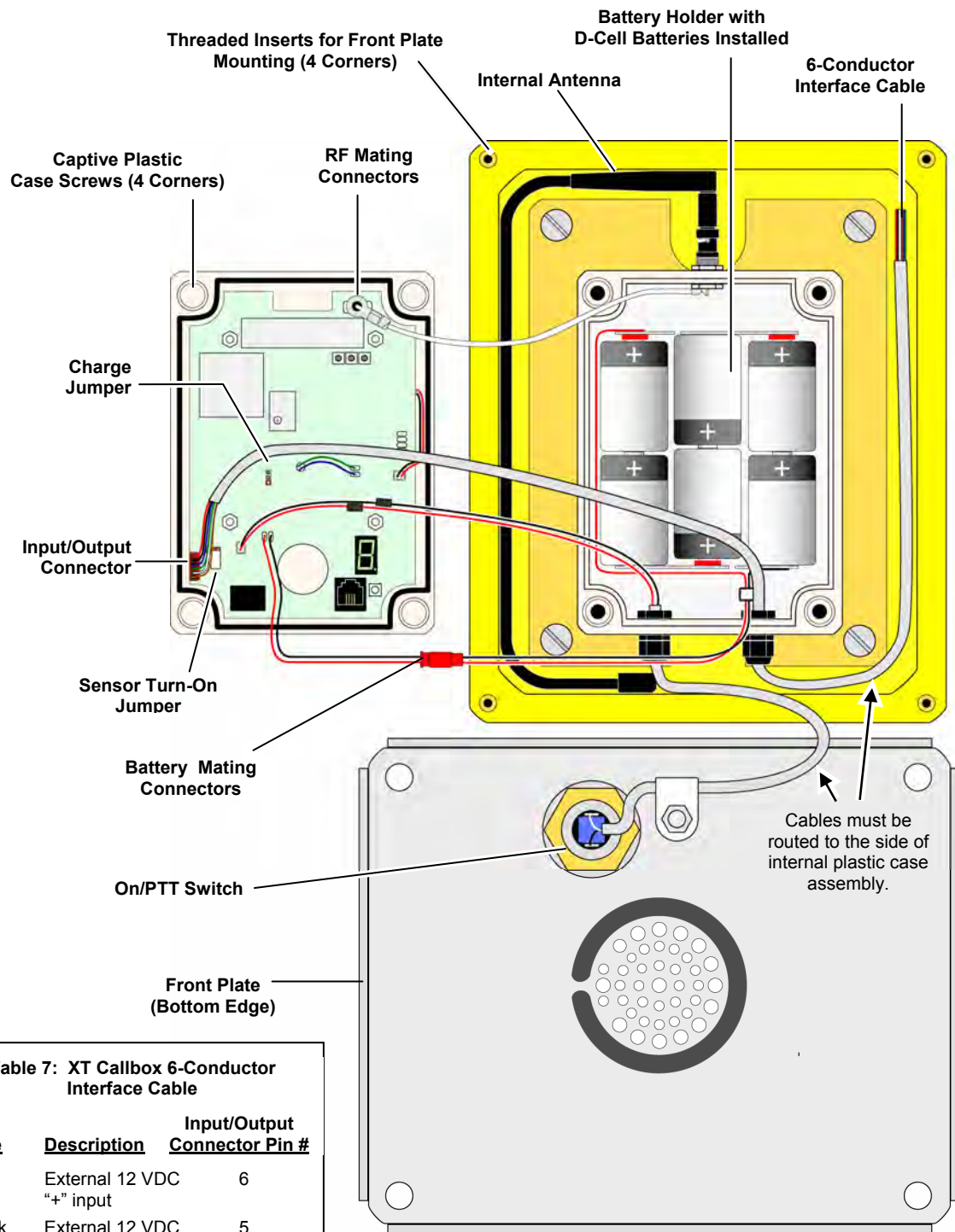

Table 7: XT Callbox 6-Conductor Interface Cable

<u>Wire</u>	<u>Description</u>	<u>Input/Output Connector Pin #</u>
Red	External 12 VDC "+" input	6
Black	External 12 VDC "-" input	5
Blue	Switch Output "+" connection	4
Green	Switch Output "-" connection	3
White	Sensor Input "+" connection	2
Brown	Sensor Input "-" ground	1

HOW TO FIELD PROGRAM THE OUTPOST® CALLBOX FOR GATEGUARD® OPERATION

The OUTPOST® can be field programmed for basic GateGuard® operation, or PC programmed to suit your unique requirements. **The instructions in this section apply only to Field Programmable features.** If PC programming software has been used to set 2-Tone decode (receive) or other optional GateGuard® features, operation may not be as described here.

Follow these steps to program the OUTPOST® for GateGuard® operation:

1. Program the **frequency and tone codes** per the “HOW TO FIELD PROGRAM FREQUENCY & TONE CODES” instructions on page **10**.
2. Program the callbox for **GateGuard® Operation ON** per the “HOW TO FIELD PROGRAM SINGLE-DIGIT RADIO FEATURE CODES” instructions on page **14**.
3. Program the **2-Tone decode (receive) code** per the “HOW TO FIELD PROGRAM 2-TONE DECODE (RECEIVE) CODES” instructions on page **11**.

The OUTPOST® Callbox will now operate in GateGuard® mode as follows:

- The Callbox will be in “**Automatic Turn-Off**” mode. The **ON/PTT** button must first be pressed as described in “OPERATING THE 6 SERIES OUTPOST® CALLBOX WITH FACTORY DEFAULT SETTINGS” section on page **3** before normal two-way communications can be established.
- If the Callbox does not send or receive a signal for more than 10 seconds the Callbox will automatically turn off. The **ON/PTT** button must be pressed to turn the Callbox back on and receive a call.
- When the Callbox receives and decodes the correct 2-Tone code the Callbox Switch Output will momentarily **CLOSE** the switch for 1 second. The Callbox will also automatically transmit a confirmation tone back to the senders radio notifying them that the correct 2-tone code has been decoded at the OUTPOST® Callbox.

OPTIONAL GATEGUARD® SETTING/FEATURES

The OUTPOST® can be Field Programmed, or PC programmed using special software, for customized GateGuard® applications.

Automatic Turn-Off (PC or FP)

This is **ENABLED** as the Factory Default setting. The callbox will turn **OFF** when the RQX Reset Time has expired. The Reset Time is a pre-programmed amount of time of “no activity” (no calls transmitted, no calls received) before the callbox turns **OFF** in order to conserve battery life. The callbox can be turned back **ON** when the **ON/PTT** button is pressed. This is the recommended mode of operation for all battery only powered applications.

If Automatic Turn-Off is **NOT** selected the callbox does **NOT** completely turn **OFF**, but remains in the Intercom mode, allowing the callbox to receive calls at any time.

Operating the callbox with Automatic Turn-Off **DISABLED** significantly increases battery drain, and is therefore **NOT** recommended for battery only powered applications. Battery life can be increased using the Battery Saver Enable feature detailed in this section.

RQX Reset Time..... (PC or FP)

This is set from the factory for 10 seconds, but can be Field Programmed to 9 different times ranging from 5 seconds to 4 minutes, and PC programmed for 5-255 seconds. A shorter RQX Reset Time will result in increased battery life. In standard Automatic Turn-Off operation a longer inactivity timer will allow more time for a response before the callbox turns **OFF**.

Battery Saver Enable.....(PC)

When the OUTPOST® Callbox is programmed to operate with Automatic Turn-Off **DISABLED**, Battery Saver can increase battery life in both internal or external battery powered applications.

With Battery Saver Enable, the callbox will periodically Wake-Up and listen for a received signal before returning to a low current Sleep mode. The sleep time can be PC programmed between 0.5 - 8 seconds with the Battery Saver Sleep Time setting. A longer sleep time will result in increased battery life, but may result in missed calls.

The callbox immediately leaves Battery Saver mode any time the **ON/PTT** Button is pressed or a signal is received, and will not return to Battery Saver until the period of no activity exceeds the RQX Reset Time.

External +12 VDC Power Fail Alert Tone(PC or FP)

By selecting the +12 VDC Power Fail Alert Tone feature the callbox will look for a loss of the +12 VDC power source. The callbox will immediately transmit an Alert Tone to notify personnel that the +12 VDC source has been lost and is now operating on battery back-up. The callbox will transmit an Alert Tone once every hour until the +12 VDC power source is restored or until the back-up batteries are exhausted. Even if this feature is **NOT** selected, it will always revert to Back-up Battery power, see page **4** for details.

NOTE: In applications where external power is available, we recommend using the RPS-EXPO Cube Power Supply. See page **4** for details.

OPTIONAL GATEGUARD® SETTING/FEATURES (CONTINUED)**Send Call Tone..... (PC or FP)**

The Factory Default setting has the Call Tone feature **ON** (refer to "HOW TO FIELD PROGRAM SINGLE-DIGIT RADIO FEATURE CODES" on page 14). The callbox can be programmed to transmit a Call Tone if the Reset Time has expired and the **ON/PTT** button is pressed. This will alert system users that the call is originating from the callbox.

Ring Tone..... (PC)

This will sound an alert tone on the callbox speaker, similar to a telephone ring tone, whenever the correct 2-tone code has been successfully decoded. This feature is used to alert the Callbox user that the gate is being **opened** or **closed**. Ring Tone is enabled from the factory.

GateGuard® – Toggle (PC or FP)

Will alternately open and close the Switch Output when it receives a unique 2-Tone code. After the 2-tone decode (receive) code is received the callbox will transmit a single beep if the switch has been **opened** and a double beep if the switch has been **closed**. The switch will open when the callbox turns off if it is programmed for Automatic Turn-Off.

GateGuard® On Code / Off Code (PC)

This operation allows programming of separate **ON** and **OFF** 2-tone decode (receive) codes. The OUTPOST® will **CLOSE** the Switch Output upon receiving the **ON** code, and **OPEN** the Switch Output upon receiving the **OFF** code.

When reading out the radio programming as described in the "HOW TO READOUT CURRENT RADIO FREQUENCY & TONE CODES" section, the **ON** code will be displayed.

Sensor/Contact Closure Input

The Sensor Input will detect a logic level and transmit an Alert tone when a change in logic level is detected. Separate alert tones are used for **OPEN** (logic level high) tone and **CLOSED** (logic level low) tone.

Busy Channel TX Inhibit (PC or FP)

This will not allow you to transmit when another user is already transmitting on your radio frequency, even if they are using a different tone code. The radio will beep a series of long, low tones (like a busy signal) while the **ON/PTT** button is held down.

FCC Licensing

The FCC requires the owners of the radios to obtain a station license before using them.

The station licensee is responsible for ensuring that transmitter power, frequency and deviation are within the limits specified by the station license. The station licensee is also responsible for proper operation and maintenance of the radio equipment. This includes checking the transmitter frequency and deviation periodically, using appropriate methods.

To get an FCC license for VHF or UHF frequencies, submit FCC application Form 601. Your Ritron dealer can help you with this process.

How to Obtain an FCC Radio License

Because your Ritron radio operates on Private Land Mobile frequencies, it is subject to the Rules and Regulations of the FCC, which requires all operators of these frequencies to obtain a station license before operating their equipment. Make application for your FCC license on FCC Forms 601, Schedules D and H, and Fee Remittance Form 159.

To have forms and instructions faxed to you by the FCC, call the FCC Fax-On-Demand system at **202-418-0177** from your fax machine; request Document numbers 3000159, 3060001, 3060003, and 3060006.

To have Document numbers 3000159, 3060001, 3060003, and 3060006 mailed to you, call the FCC Forms Hotline at **800-418-FORM (800-418-3676)**.

For help with questions concerning the license application, contact the FCC at **888-CALL-FCC (888-225-5322)** or log on at www.fcc.gov

You must decide which radio frequency(ies) you can operate on before filling out your application.

For help determining your frequencies, call Ritron at **800-USA-1-USA (800-872-1872)**.

Safety Standards

The FCC (with its action in General Docket 79-144, March 13, 1985) has adopted a safety standard for human exposure to radio frequency electromagnetic energy emitted by FCC regulated equipment. Ritron observes these guidelines and recommends that you do also:

- DO NOT hold the radio so that the antenna is very close to or touching exposed parts of the body, especially the face or eyes, while transmitting. Keep the radio vertical, eight inches away while talking into the front panel.
- DO NOT press the Push-To-Talk except when you intend to transmit.
- DO NOT operate radio equipment near electrical blasting caps or in an explosive atmosphere.
- DO NOT allow children to play with any radio equipment that contains a transmitting device.
- Repair of Ritron products should be performed only by Ritron authorized personnel.

INDUSTRY CANADA Regulations

Industry Canada requires the owners of the radios to obtain a radio license before using them.

Application forms can be obtained from the nearest Industry Canada District office.

INDUSTRY CANADA License Application

1. Fill in the items per the instructions. If you need additional space for any item, use the reverse side of the application.
2. Use a typewriter or print legibly.
3. Make a copy for your files.
4. Prepare a check or money order to "Receiver General for Canada", for the amount listed on the following schedule for each radio purchased. (Licenses are renewed annually on April 1st. Refer to the following schedule for application fees for each month.)
5. Mail the completed application, along with your check or money order, to the closest Industry Canada District Office.

Month of Application	Initial Fee	Month of Application	Initial Fee
April.....	\$52	October.....	\$33
May.....	\$50	November.....	\$29
June.....	\$46	December.....	\$26
July.....	\$43	January.....	\$23
August.....	\$40	February.....	\$20
September.....	\$36	March.....	\$16

Notes: Fees are subject to change without notice. The annual renewal fee is \$41

WHAT THIS WARRANTY COVERS:

RITRON, INC. ("RITRON") provides the following warranty against defects in materials and/or workmanship in **RITRON Radios and Accessories** under normal use and service during the applicable warranty period (as stated below). "Accessories" means antennas, holsters, chargers, earphones, speaker/microphones and items contained in the programming and programming/service kits.

<u>WHAT IS COVERED</u>	<u>FOR HOW LONG</u>	<u>WHAT RITRON WILL DO</u>
OUTPOST® Callboxes	1 year*	During the first year after date of purchase, RITRON will repair or replace the defective product, at RITRON's option, parts and labor included at no charge.
Accessories	90 days*	<i>*After date of purchase</i>

WHAT THIS WARRANTY DOES NOT COVER:

- Any technical information provided with the covered product or any other RITRON products;
- Installation, maintenance or service of the product, unless this is covered by a separate written agreement with RITRON;
- Any products not furnished by RITRON which are attached or used with the covered product, or defects or damage from the use of the covered product with equipment that is not covered (such as defects or damage from the charging or use of batteries other than with covered product);
- Defects or damage, including broken antennas, resulting from:
 - misuse, abuse, improper maintenance, alteration, modification, neglect, accident or act of God,
 - the use of covered products other than in normal and customary manner or,
 - improper testing or installation;
- Defects or damages from unauthorized disassembly, repair or modification, or where unauthorized disassembly, repair or modification prevents inspection and testing necessary to validate warranty claims;
- Defects or damages in which the serial number has been removed, altered or defaced.
- Batteries if any of the seals are not intact.

IMPORTANT: This warranty sets forth the full extent of RITRON's express responsibilities regarding the covered products, and is given in lieu of all other express warranties. What RITRON has agreed to do above is your sole and exclusive remedy. No person is authorized to make any other warranty to you on behalf of RITRON. Warranties implied by state law, such as implied warranties of merchantability and fitness for a particular purpose, are limited to the duration of this limited warranty as it applies to the covered product. Incidental and consequential damages are not recoverable under this warranty (this includes loss of use or time, inconvenience, business interruption, commercial loss, lost profits or savings). Some states do not allow the exclusion or limitation of incidental or consequential damages, or limitation on how long an implied warranty lasts, so the above limitations or exclusions may not apply to you. Because each covered product system is unique, RITRON disclaims liability for range, coverage, or operation of the system as a whole under this warranty.

WHO IS COVERED BY THIS WARRANTY: This warranty is given only to the purchaser or lessee of covered products when acquired for use, not resale. This warranty is not assignable or transferable.

HOW TO GET WARRANTY SERVICE: To receive warranty service, you must deliver or send the defective product, delivery costs and insurance prepaid, within the applicable warranty period, to **RITRON, INC., 505 West Carmel Drive, Carmel, Indiana 46032, Attention: Warranty Department**. Please point out the nature of the defect in as much detail as you can. You must retain your sales or lease receipt (or other written evidence of the date of purchase) and deliver it along with the product. If RITRON chooses to repair or replace a defective product, RITRON may replace the product or any part or component with reconditioned product, parts or components. Replacements are covered for the balance of the original applicable warranty period. All replaced covered products, parts or components become RITRON's property.

RIGHTS TO SOFTWARE RETAINED : Title and all rights or licenses to patents, copyrights, trademarks and trade secrets in any RITRON software contained in covered products are and shall remain in RITRON. RITRON nevertheless grants you a limited non-exclusive, transferable right to use the RITRON software only in conjunction with covered products. No other license or right to the RITRON software is granted or permitted.

YOUR RIGHTS UNDER STATE LAW: This warranty gives you specific legal rights, and you may also have other rights which vary from state to state.

WHERE THIS WARRANTY IS VALID: This warranty is valid only within the United States, the District of Columbia and Puerto Rico.