

Professional Two-Way Radio

PT Series User Manual

Models: VHF PT-150 • UHF PT-450

- **Analog, Narrow Band Capable**
- **Narrower Frequency Channel Steps**
VHF: 2.5/12.5kHz
UHF: 2.5/6.25/12.5kHz
- **2-Tone Decode 300-3000Hz**
- **Loud Audio Output - 1000mW**
- **MIL STD 810F Temperature/Humidity/
Shock/Vibration**
- **IP65 Certified Resistance to Water/Dust**

CONTENTS	PAGE
Included Items.....	1
Accessories.....	2
Controls and Functions	3
Charger Information.....	3
Antenna Installation.....	3
LCD Display Indicators.....	4
Battery Information.....	4
Operating Your Radio	5
Programmable Functions	6-9
CTCSS / DCS TONE chart.....	9
FCC Regulations.....	9
RF Energy Exposure Information...	10
Ritron Warranty Information	11

ITEMS INCLUDED WITH EACH RADIO

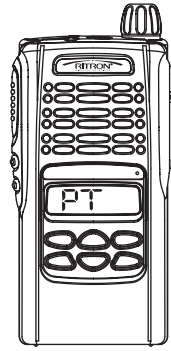

PT Radio

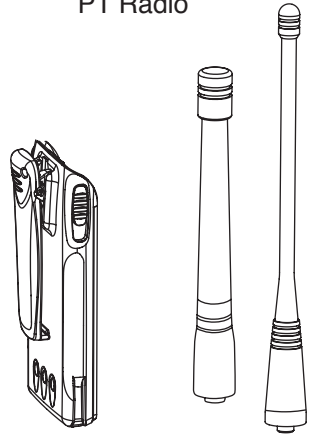

Li-Ion Battery w/ Belt Clip

VHF or UHF Antenna

Models	Description
PT-150	VHF, *136-174MHz 5 Watt or 1 Watt 255 Channel Capacity
PT-450	UHF, *406-470MHz 4 Watt or 1 Watt 255 Channel Capacity

*Standard antenna supplied is cut for operation in the following frequency ranges:

- VHF:** 150-165MHz
- UHF:** 450-470MHz

Operation on frequencies outside this range will require custom cut antenna.

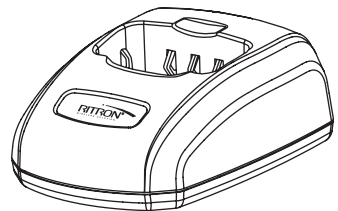

Single Slot Rapid Charger

ACCESSORIES	Part No.
Ear Loop with PTT & Microphone	RHD-15X
Speaker Microphone	RSM-6X
Replacement, Battery Pack	BP-Li-PT
Replacement, Belt Clip	CB-PT



RSM-6X

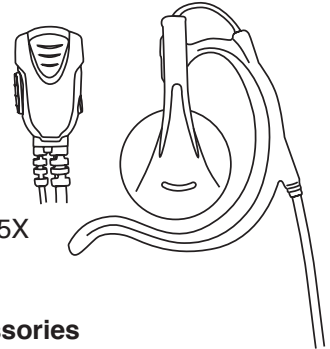

RHD-15X

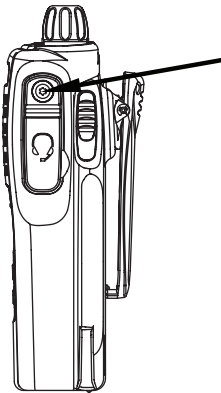

Installing Audio Accessories

1. Remove the 1 Torx fastener that secures the audio accessory dust cover to the radio.
2. Attach the Ritron audio accessory connector to the radio using the 2 captive screws in the audio accessory connector.
3. Do NOT over-tighten or use excessive force when securing the mounting screws to the radio

Battery Installation/Removal

1. Turn the radio OFF.
2. Align tabs at bottom of battery pack with the slots at the bottom of the radio body.
3. Pivot the top of the battery towards the radio body until you hear the spring latches engage with a click.

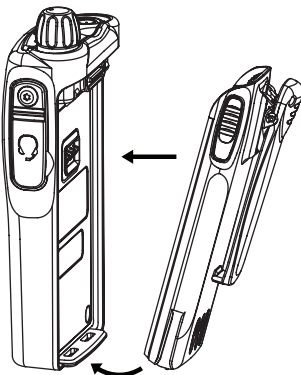

2.

To Remove

1. Turn radio OFF.
2. Slide both side latches down until they release.
3. Gently rotate the top of the battery pack away from the radio.

Getting To Know Your PT Series Radio

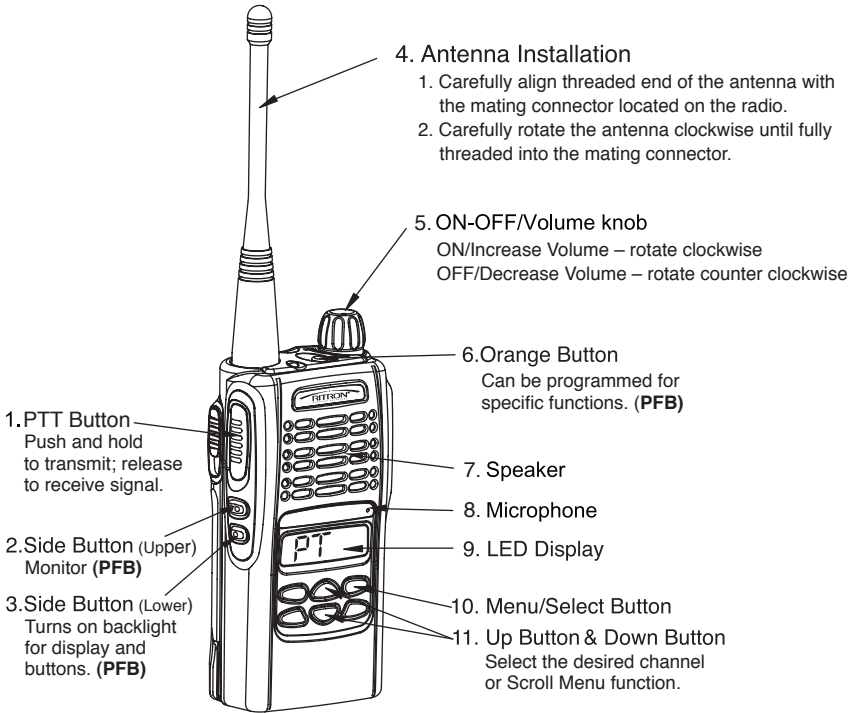

PFB denotes Programmable Function Button
P1, P2, P3 are PFB's
 (see page 5.)

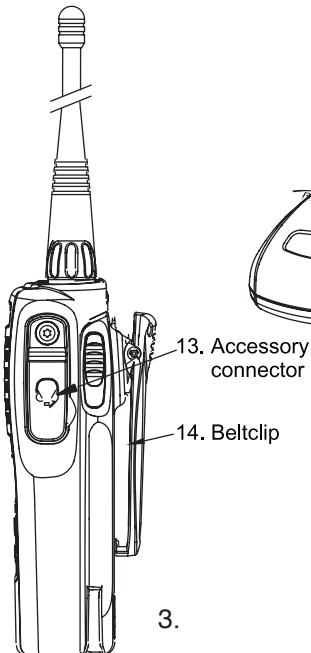

BC-PT Charger Information

Specification

- Input voltage: 12VDC, 1A
- Output voltage: 8.4VDC, 850mA
- Charge time: 2 1/2 hours

Operating instruction









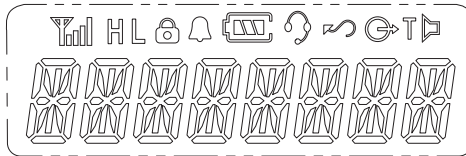

- Plug the AC power cord of the charger into a wall outlet.
- Turn the transceiver off.
- Insert the battery pack into the charger with or without the transceiver attached.

Color Status of Charger LED

- Steady RED.....Battery Charging
- Steady GREEN....Battery Charging Complete
- Steady AMBER....Trickle Charge, Replace Battery
- Blinking AMBER...Abnormal Temperature
- Blinking RED.....Replace Battery

Display Indicators



Indicator	Description
	Indicates relative signal strength level.
	Power Level Indicator. "H" is high power. "L" is low power.
	Keypad Lock Indicator. Appears when keypad lock function is ON.
	Alert(Beep) ON/OFF Indicator. Appears when keypad tones are ON.
	Battery Level Indicator. Indicates remaining battery power.
	Hands-free VOX Indicator. Appears when VOX function is turned ON.
	Channel Scan Indicator. Appears when Scan function is activated.
	Talk - Around Indicator.
	TONE Indicator. Appears when the frequency is set with Tone.
	Monitor Indicator. Appears when Monitor Button is pressed.

Battery Information

- Fully charge the battery before use to keep the optimum capacity and for safe operation.
- The battery is designed for the PT Series charger only. Please do not charge the battery with any other brand charger.
- Turn the radio off before charging.
- Do not disassemble.
- If the battery terminal is contacted with any metals or conductive substances, it may do harm to the body or battery.
- **Battery Type:** Rechargeable Lithium-Ion
- **Battery Life:** Duty cycle: 5% transmit, 5% receive, 90% standby = more than 12 hours

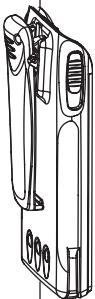





Operating Your PT Series Radio

- Select the desired channel by using the Up/ Down button. When held down, channels change continuously.
- To Monitor channel activity, press the monitor button on the side.
- To Talk, press and hold the PTT button, speak into the microphone on the radio, and release to listen.

Note: For maximum clarity hold the radio 2-3 inches away from your mouth and speak in a normal tone of voice.

Programmable Function Buttons (PFB's)







Programmable Function Buttons (PFB) provide easy, one-button access to a specific feature/function. Your dealer can program the PFB to have: no function when pressed, toggle ON or OFF a specific feature, transmit a Call Tone or a variety of other features/functions. The following table indicates the Factory Default setting for each of the PFB's on your radio. The default function can be changed via PC programming by your Ritron dealer.

PF Button	Factory Default Function	Description of Function
#6. Orange (top)	No Function	None
#2. Side Button (Upper)	Monitor	If radio is programmed with sub-tone, momentarily press the Monitor Button (left side), to toggle between sub-tone, no sub-tone or open squelch (you will hear squelch noise).
#3. Side Button (Lower)	Backlight	Turns ON the backlight of the display and backlit front buttons.
P1	TX Pwr Level	Transmitter toggles between high power (4W@UHF, 5W@VHF) and low power (1W). H=High, L=Low pwr.
P2	Keypad Lock	
P3	Scan	Radio will begin to scan designated channels. A channel <i>must be flagged</i> using PC Programmer in order to be included in scan list. Scan symbol will appear in display.
	Nuisance Channel Delete while in Scan Mode	Allows user to temporarily delete nuisance channels from the scan list. When radio is in scan mode and stops on the nuisance channel, PRESS and HOLD the Scroll Down Button. Display will flash "DELETED" when complete. Nuisance Channel is now temporarily deleted from scan list. To restore deleted channel, turn the radio OFF then ON again.
#11.  	Scroll Up Scroll Down	Scroll Channels or feature sub-list. Scroll Channels or feature sub-list.
#10. 	MENU/ENTER	Allows access to MENU enabled features and/or ENTER key.

Using The Menu/Enter Button

Using the PT Series special PC programming software your dealer can enable or disable access to certain features from the radio MENU button. Listed below are instructions for accessing these feature/functions from the radio MENU button. The MENU/ENTER button can also be assigned to have no function when pressed.

To access feature/functions via the radio MENU:

- Press  if enabled, the first feature/function in the list will appear on the LCD display
- Use   to scroll to a specific feature/function or
- Press  to ENTER the feature/function appearing on the LCD display
- Use   to scroll sub-list option settings for the specific feature/function
- Press  to SAVE selection and exit MENU
- The last channel of operation will appear on the LCD display

Programmable PT Series Radio Features

Your dealer can enable or disable access to the following features/functions. Listed below is a description of each. The grid below indicates if the feature can be:
(1) Assigned to a specific programmable function button, and/or
(2) If the function can be programmed to be accessible via the radio's MENU mode.
 Ask your dealer for details on the specific operation of these functions.

	PF Assignable	Menu Accessible
No Function Assigned For most basic applications and ease-of-use. If enabled, the PF button will have no function when pressed.	Yes	No
Menu Button Activates the radio menu feature, menu selections will appear on the display.	Yes	No
Up/Down Scroll Buttons Scroll Up/Down any selection list. This includes channel list, menu list, contact list, status list, RX or TX tone list, and variable level settings.	Yes	No
Monitor/Call Cancel Will toggle sequentially between: tone, carrier, and open squelch mode, or will clear the display of any incoming call.	Yes	No
Emergency Call Allows user to send an Emergency Call/Message on a pre-defined channel to other radios.	Yes	No
Ex: If radio user should become injured, or is in danger. A push of the orange button activates the Emergency Call function. Ask your dealer for specific details and operation of this feature.		
Backlight ON/OFF Turns the display backlight On or Off.	Yes	No
Send A Call Tone You can transmit a Call Tone to other radios in your group to alert them you are about to talk. Radio transmits alternating tones for as long as the programmable function button is pressed.	Yes	No

continued...

	PF Assignable	Menu Accessible
Group Select When programmed to a programmable function button, allows quick access to a group of up to 10 pre-programmed channels.	Yes	Yes
Go To A Fixed (Pre-Set) Channel #, 1- 4 “Speed dial” for quickly accessing pre-programmed channel(s). Eliminates the need to scroll through channels. A programmable function button can be assigned to 1 of up to 4 pre-set channels.	Yes	No
Keypad Lock ON/OFF Prevents accidental activation of the front panel buttons. Icon appears on LCD display when ON.	Yes	Yes
Send A Selective Signaling Call Send a 2-tone Page Code (e.g. GateGuard command code, 5 to7 Tone Page or DTMF ANI Code on a per channel basis).	Yes	No
Alerts ON/OFF Turn keypad tones OFF for silent operation. Icon will appear on LCD display when ON.	Yes	Yes
Send DTMF Digits Radio can be programmed by your dealer to transmit unique DTMF digits on a per channel basis and/or via programmable function button.	Yes	No
Talk Around ON/OFF Causes the radio to transmit on the receive frequency on channels where the RX and TX are not the same. Icon will appear on the LCD Display when ON.	Yes	Yes
Tx/Rx Tone Select Select CTCSS or DCS encode and decode tone codes on the current operating channel.	Yes	Yes
TX Power Level Set transmit power to high, or low on current operating channel. Icon (H or L) will appear on LCD display.	Yes	Yes
Battery Saver ON/OFF Battery life extended when ON.	Yes	Yes
Missed Call Displays a list of missed Selcall calls.	Yes	Yes
Contact List Select and send from a list of pre-programmed encode codes. <small>E.g. 2-Tone GateGuard Command codes to open different gates, turn on lights, pump control etc.</small>	Yes	Yes
Status List Select & send from a list of pre-programmed “status” messages. E.g. Text messaging.	Yes	Yes
Squelch Level Will display the current squelch level and allow the user to raise or lower squelch with the Up and Down buttons. Smaller numbers increase squelch sensitivity, allowing the radio to hear weak and distant signals. Larger numbers decrease sensitivity, only strong signals are heard.	Yes	Yes
Missed Call List Delete Clears the Missed Call List.	No	Yes
Missed Call Send Will automatically send the Current Status message if a Missed Call is detected.	No	Yes

	PF Assignable	Menu Accessible
Password Prevents unauthorized use of the radio. At radio turn on user must enter 4 character password before radio will operate. Password is entered using the Up/Dwn scroll buttons and MENU button.	Yes	Yes
Normal Scan ON/OFF Must be programmed by your dealer. Channels <i>must be flagged</i> as eligible scan channels. Normal Scan will periodically check these channels to prevent missed calls. Programmable function button can be set to turn function ON or OFF. Icon will appear on LCD display when scan is ON.	Yes	Yes
Priority Scan ON/OFF Must be enabled by your dealer. Designates a priority channel that is checked more frequently than other channels to prevent missed calls.	Yes	Yes
Priority Scan Channel Allows the user to set the priority channel from a list of available channels.	No	Yes
Nuisance Channel Delete Allows user to temporarily delete nuisance channels from the scan list. When radio is in scan mode and stops on the nuisance channel, PRESS and HOLD the Scroll Down Button. Display will flash "DELETED" when complete. Nuisance Channel is now temporarily deleted from scan list. To restore deleted channel, turn the radio OFF then ON again.	No	No
"Hands-Free" VOX ON/OFF Allows "hands-free" use of the radio, with or without an audio accessory. (I.e. a headset). Icon will appear on LCD display when ON.	Yes	Yes
VOX Level Allows user to select the voice audio level required to "key" the transmitter. VOX Level can be set from 0-15. A higher number makes the VOX circuit "MORE" sensitive ("less" audio is required) to trigger VOX operation. A lower number makes the VOX circuit "LESS" sensitive ("more" audio is required).	No	Yes
Ear PTT ON/OFF Enables or disables microphone on radio. Allows use of earbud (listen only) device while microphone on radio remains enabled.	No	Yes
LED Indicator ON/OFF LED on top of the radio can be set to "blink" green every 10 seconds.	No	Yes
Lone Worker Useful in situations where the radio user works alone and is either required to or it would be helpful to check in at regular intervals. PT Radio can be programmed to sound a tone to remind the Lone Worker that they must "call in". If they do not call in within the specified period, radio will automatically send the Emergency code.	No	Yes
Radio Reset See your Dealer for details	No	Yes

continued...

Caller/Group ID Each transmission (16 possible codes) is uniquely identified. Receiving radios show name of caller/group on LCD display.

No No

Selcall (Selective Calling) 2-Way Paging Selcall is a voice call to a specific radio or group of radios. The caller selects the radio or group of radios from a pre-programmed "contact list."

No Yes

Status Messaging Send and receive pre-programmed alpha/numeric status messages.

No Yes

[Ack]nowledge Sending radio receives an [Ack]nowledge message confirming that the Selcall or Status Message has been received.

No No

CTCSS (Continuous Tone Coded Squelch System) Frequency Chart

No.	Freq (Hz)	No.	Freq (Hz)	No.	Freq (Hz)	No.	Freq (Hz)
001	67.0	013	103.5	025	156.7	037	241.8
002	71.9	014	107.2	026	162.2	038	250.3
003	74.4	015	110.9	027	167.9	039	069.3
004	77.0	016	114.8	028	173.8	040	159.8
005	79.7	017	118.8	029	179.9	041	183.5
006	82.5	018	123.0	030	186.2	042	189.9
007	85.4	019	127.3	031	192.8	043	196.6
008	88.5	020	131.8	032	203.5	044	199.5
009	91.5	021	136.5	033	210.7	045	206.5
010	94.8	022	141.3	034	218.1	046	229.1
011	97.4	023	146.2	035	225.7	047	254.1
012	100.0	024	151.4	036	233.6		

FCC REGULATIONS LICENSING

The FCC requires the owners or PT Series radios to obtain a station license before using them. The station licensee is responsible for ensuring that transmitter power, frequency and deviation are within the limits specified by the station license. The station licensee is also responsible for proper operation and maintenance of the radio equipment. This includes checking the transmitter frequency and deviation periodically, using appropriate methods. To get a FCC license for VHF or UHF frequencies, contact your Ritron dealer for help with this process.

SERVICE

Federal law prohibits you from making any internal adjustments to the transmitter and/or from changing transmit frequencies unless you are specifically designated by the licensee.

SAFETY STANDARDS

The FCC (with its action in General Docket 79-144, (March 13, 1985) has adopted a safety standard for human exposure to radio frequency electromagnetic energy emitted by FCC regulated equipment. Ritron observes these guidelines and recommends that you do also:

- DO NOT hold the radio so that the antenna is very close to or touching exposed parts of the body, especially the face or eyes, while transmitting. Keep the radio vertical, four inches away while talking into the front panel.
- DO NOT press the Push-To-Talk except when you intend to transmit.
- DO NOT operate radio equipment near electrical blasting caps or in an explosive atmosphere.
- DO NOT allow children to play with any radio equipment that contains a transmitting device.

DCS (Digital Coded Squelch) Code Chart

No.	Code	No.	Code	No.	Code	No.	Code	No.	Code	No.	Code
101	023	119	131	137	261	155	431	173	654	191	252
102	025	120	132	138	263	156	432	174	662	192	255
103	026	121	134	139	265	157	445	175	664	193	266
104	031	122	143	140	271	158	464	176	703	194	274
105	032	123	152	141	306	159	465	177	712	195	325
106	043	124	155	142	311	160	466	178	723	196	332
107	047	125	156	143	315	161	503	179	731	197	356
108	051	126	162	144	331	162	506	180	732	198	446
109	054	127	165	145	343	163	516	181	734	199	452
110	065	128	172	146	346	164	532	182	743	200	454
111	071	129	174	147	351	165	546	183	754	201	455
112	072	130	205	148	364	166	565	184	053	202	462
113	073	131	223	149	365	167	606	185	122	203	523
114	074	132	226	150	371	168	612	186	036	204	526
115	114	133	243	151	411	169	624	187	145		
116	115	134	244	152	412	170	627	188	212		
117	116	135	245	153	413	171	631	189	225		
118	125	136	251	154	423	172	632	190	246		

RF ENERGY EXPOSURE AWARENESS AND CONTROL INFORMATION
RF ENERGY EXPOSURE AWARENESS AND CONTROL INFORMATION, AND
OPERATIONAL INSTRUCTIONS FOR FCC OCCUPATIONAL USE REQUIREMENTS

BEFORE USING YOUR PORTABLE 2-WAY RADIO, READ THIS IMPORTANT RF ENERGY AWARENESS AND CONTROL INFORMATION AND OPERATIONAL INSTRUCTIONS TO ENSURE COMPLIANCE WITH THE FCC'S RF EXPOSURE GUIDELINES.

NOTICE: This radio is intended for use in occupational/controlled conditions, where users have full knowledge of their exposure and can exercise control over their exposure to meet FCC limits. This radio device is NOT authorized for general population, consumer, or any other use.

This 2-way radio uses electromagnetic energy in the radio frequency (RF) spectrum to provide communications between two or more users over a distance. It uses radio frequency (RF) energy or radio waves to send and receive calls. RF energy is one form of electromagnetic energy. Other forms include, but are not limited to, electric power, sunlight and x-rays. RF energy, however, should not be confused with these other forms of electromagnetic energy, which when used improperly can cause biological damage. Very high levels of x-rays, for example, can damage tissues and genetic material.

Experts in science, engineering, medicine, health and industry work with organizations to develop standards for exposure to RF energy. These standards provide recommended levels of RF exposure for both workers and the general public. These recommended RF exposure levels include substantial margins of protection. All 2-way radios marketed in North America are designed, manufactured and tested to ensure they meet government established RF exposure levels. In addition, manufacturers also recommend specific operating instructions to users of 2-way radios. These instructions are important because they inform users about RF energy exposure and provide simple procedures on how to control it. Please refer to the following websites for more information on what RF energy exposure is and how to control your exposure to assure compliance with established RF exposure limits.

<http://www.fcc.gov/oet/rfsafety/rf-faqs.html> <http://www.fcc.gov/oet/rfsafety/rf-faqs.html>
<http://www.osha.gov/SLTC/radiofrequencyradiation/index.html>
<http://www.osha.gov/SLTC/radiofrequencyradiation/index.html>

FEDERAL COMMUNICATIONS COMMISSION REGULATIONS -The FCC rules require manufacturers to comply with the FCC RF energy exposure limits for portable 2-way radios before they can be marketed in the U.S. When 2-way radios are used as a consequence of employment, the FCC requires users to be fully aware of and able to control their exposure to meet occupational requirements. Exposure awareness can be facilitated by the use of a product label directing users to specific user awareness information. Your Ritron PT Series 2-way radio has an RF exposure product label. Also, this user manual includes information and operating instructions required to control your RF exposure and to satisfy compliance requirements.

COMPLIANCE WITH RF EXPOSURE STANDARDS -Your Ritron 2-way radio is designed and tested to comply with a number of national and international standards and guidelines (listed below) for human exposure to radio frequency electromagnetic energy. This radio complies with the IEEE and ICNIRP exposure limits for occupational/controlled RF exposure environment at operating duty factors of up to 50% transmitting and is authorized by the FCC for occupational use only. In terms of measuring RF energy for compliance with the FCC exposure guidelines, your radio radiates measurable RF energy only while it is transmitting (during talking), not when it is receiving (listening) or in standby mode.

NOTE: The approved batteries supplied with this radio are rated for a 5-5-90 duty factor (5% talk - 5% listen - 90% standby), even though this radio complies with the FCC occupational RF exposure limits and may operate at duty factors of up to 50% talk.

Have questions? Call 800-USA-I-USA (800-872-1872) or visit our website at www.ritron.com

Your Ritron 2-way radio complies with the following RF energy exposure standards and guidelines:

- United States Federal Communications Commission, Code of Federal Regulations; 47 CFR JJ 1.1307, 1.1310, 2.1091 and 2.1093
- American National Standards Institute (ANSI)/Institute of Electrical and Electronic Engineers (IEEE) C95.3-2003
- Institute of Electrical and Electronic Engineers (IEEE) C95.3 2003Edition

RF EXPOSURE COMPLIANCE AND CONTROL GUIDELINES AND OPERATING INSTRUCTIONS -To control your exposure and ensure compliance with the occupational/controlled environment exposure limits always adhere to the following procedures.

GUIDELINES:

- Do not remove the RF Exposure Label from the device.
- This user manual should accompany device when transferred to other users.
- Do not use this device if the operational requirements described herein are not met.

OPERATING INSTRUCTIONS:

- Transmit no more than the rated duty factor of 50% of the time. To transmit (talk), push the Push-To-Talk (PTT) button. To receive calls, release the PTT button. Transmitting 50% of the time, or less, is important because this radio generates measurable RF energy exposure only when transmitting (in terms of measuring for standards compliance).
- Hold the radio in a vertical position in front of face with the microphone (and the other parts of the radio, including the antenna) at least one inch (2.5 cm) away from the nose. Keeping the radio at the proper distance is important because RF exposures decrease with distance from the antenna. Antenna should be kept away from eyes.
- When worn on the body, always place the radio in a Ritron approved clip, holder, holster, case, or body harness for this product. Using approved body-worn accessories is important because the use of other manufacturers' non-approved accessories may result in exposure levels, which exceed the FCC's occupational/controlled environment RF exposure limits.
- If you are not using a body-worn accessory and are not using the radio in the intended use position in front of the face, then ensure the antenna and the radio are kept at least 2.5 cm (one inch) from the body when transmitting. Keeping the radio at the proper distance is important because RF exposures decrease with increasing distance from the antenna.
- Use only Ritron approved supplied or replacement antennas, batteries, and accessories. Use of non-Ritron approved antennas, batteries, and accessories may exceed the FCC RF exposure guidelines.
- For a list of Ritron approved accessories see this user manual, or visit <http://www.ritron.com> <http://www.ritron.com>, or call Ritron at **800-872-1872**.

CONTACT INFORMATION

For additional information on exposure requirements or other information, contact Ritron at 800-872-1872.

Have questions? Call 800-USA-I-USA (800-872-1872) or visit our website at <http://www.ritron.com>

RITRON, INC. LIMITED WARRANTY

WHAT THIS WARRANTY COVERS:

RITRON, INC. ("RITRON") provides the following warranty against defects in materials and/or workmanship in RITRON Radios and Accessories under normal use and service during the applicable warranty period (as stated below). "Accessories" means antennas, holsters, chargers, earphones, speaker/microphones and items contained in the programming and programming/service kits.

WHAT IS COVERED	FOR HOW LONG	WHAT RITRON WILL DO
PT Series Radios	1 year*	During the first year after date of purchase, RITRON will repair or replace the defective product, at RITRON's option, parts and labor included at no charge.
Accessories	90 days*	*After date of purchase

WHAT THIS WARRANTY DOES NOT COVER:

- Any technical information provided with the covered product or any other RITRON products;
- Installation, maintenance or service of the product, unless this is covered by a separate written agreement with RITRON;
- Any products not furnished by RITRON which are attached or used with the covered product, or defects or damage from the use of the covered product with equipment that is not covered (such as defects or damage from the charging or use of batteries other than with covered product);
- Defects or damage, including broken antennas, resulting from:
 - misuse, abuse, improper maintenance, alteration, modification, neglect, accident or act of God,
 - the use of covered products other than in normal and customary manner or,
 - improper testing or installation;
- Defects or damages from unauthorized disassembly, repair or modification, or where unauthorized disassembly, repair or modification prevents inspection and testing necessary to validate warranty claims;
- Defects or damages in which the serial number has been removed, altered or defaced.
- Batteries if any of the seals are not intact.

IMPORTANT: This warranty sets forth the full extent of RITRON's express responsibilities regarding the covered products, and is given in lieu of all other express warranties. What RITRON has agreed to do above is your sole and exclusive remedy. No person is authorized to make any other warranty to you on behalf of RITRON. Warranties implied by state law, such as implied warranties of merchantability and fitness for a particular purpose, are limited to the duration of this limited warranty as it applies to the covered product. Incidental and consequential damages are not recoverable under this warranty (this includes loss of use or time, inconvenience, business interruption, commercial loss, lost profits or savings). Some states do not allow the exclusion or limitation of incidental or consequential damages, or limitation on how long an implied warranty lasts, so the above limitations or exclusions may not apply to you. Because each covered product system is unique, RITRON disclaims liability for range, coverage, or operation of the system as a whole under this warranty.

WHO IS COVERED BY THIS WARRANTY:

This warranty is given only to the purchaser or lessee of covered products when acquired for use, not resale. This warranty is not assignable or transferable.

HOW TO GET WARRANTY SERVICE:

To receive warranty service, you must deliver or send the defective product, delivery costs and insurance prepaid, within the applicable warranty period, to

**RITRON, INC., 505 West Carmel Drive, Carmel, Indiana 46032,
Attention: Warranty Department.**

Please point out the nature of the defect in as much detail as you can. You must retain your sales or lease receipt (or other written evidence of the date of purchase) and deliver it along with the product. If RITRON chooses to repair or replace a defective product, RITRON may replace the product or any part or component with reconditioned product, parts or components. Replacements are covered for the balance of the original applicable warranty period. All replaced covered products, parts or components become RITRON's property.

RIGHTS TO SOFTWARE RETAINED :

Title and all rights or licenses to patents, copyrights, trademarks and trade secrets in any RITRON software contained in covered products are and shall remain in RITRON. RITRON nevertheless grants you a limited non-exclusive, transferable right to use the RITRON software only in conjunction with covered products. No other license or right to the RITRON software is granted or permitted.

YOUR RIGHTS UNDER STATE LAW: This warranty gives you specific legal rights, and you may also have other rights which vary from state to state.

WHERE THIS WARRANTY IS VALID: This warranty is valid only within the United States, the District of Columbia and Puerto Rico.