

# **JOB COM<sup>®</sup> JMX "FOUR SERIES" OWNER'S MANUAL**



## **"FOUR SERIES" HANDHELDS COMPACT ULTRA-SMALL PROFESSIONAL TWO-WAY RADIOS**

- 1, 2, 3, or 4 channel capability
- Easier, enhanced programming method
- 1, 2, 3, or 4 Watt models
- Quick-change battery
- Drop-in charge capable
- Weather scan 🌤️ feature (VHF only)
- Easy-to-hear, high audio output
- Built-in Quiet Call<sup>®</sup> Interference Eliminator
- Customer-selectable frequency settings



# ACCESSORIES

## OPTIONAL ACCESSORIES:

**TO ORDER, CALL 800-USA-1-USA.**

- BPJS-6N ..... Spare/Replacement JMX Battery  
 (for JMX-141/146/146XP/446/446XP/441)
- BPS-6N-SC ..... Spare/Replacement Battery  
 (for JMX-144/444)
- BPS-6N-MH ..... Replacement High Capacity Battery  
 (fits all JMX models)



RHD-1X  
Single Ear Headset



RHD-6X  
Behind-the-head Earset



RHD-4X  
Dual Ear Headset



RHD-5X  
Over-the-ear Earset



RSM-3X  
Remote Speaker Mic

- AFS-150 ..... VHF Molded Flex Antenna  
 AFS-450 ..... UHF Molded Flex Antenna
- RHD-1X ..... Single Ear Headset  
 RHD-4X ..... Dual Ear Headset  
 RHD-5X ..... Lightweight Over-the-ear Earset /w In-line PTT  
 RHD-6X ..... Lightweight Behind-the-head Earset w/ In-line PTT
- RSM-3X ..... Remote Speaker Microphone  
 REP-2 ..... Low Profile Earphone
- CCL-B ..... Cigarette Lighter Charger
- MHS-A ..... Cordura Holster w/quick release
- BCJS-4AD ..... 4-Well Drop-in Charger: JMX  
 BCJS-AD ..... Single-Well Drop-in Charger: JMX (Overnight)



BCJS-4AD  
4-Well Drop-in Charger



MHS-A  
Swivel Holster

*Call RITRON for complete listings.*

The NEW "Four Series" models contain updated programming features, and program differently than other JMX portables. These radios provide more channels, allow you to change channel programming contents individually, and also allow you to delete one or more channels, and add it back in, if needed.

www.TwoWayRadioEquipment.com | (800) 878-7829 | Sales@TwoWayRadioEquipment.com  
 Have questions? Call **800-USA-1-USA** (800-872-1872) or visit our website at [www.ritron.com](http://www.ritron.com)

# TABLE OF CONTENTS

<u>DESCRIPTION</u>	<u>PAGE</u>
<b>ACCESSORIES</b>	
Optional Accessories .....	ii
<b>INTRODUCTION</b>	
General .....	
Inspection .....	
"Four Series" Model Numbers .....	
Model Identification .....	
New Programming Method .....	
FIG-1: Belt Clip Installation .....	
<b>CONTROL &amp; OPERATION</b> .....	2
FIG-2: Radio Controls and Connectors .....	2
<b>OPERATION</b>	
Weather Scan (VHF Radios Only) .....	3
FIG-3: To Scan Weather Frequencies .....	3
What The Radio Tones Mean .....	3
Interference Eliminator Codes .....	3
<b>TO DETERMINE FREQUENCIES &amp; CODES IN "FOUR SERIES" JMX</b>	
Select Each Channel to Beep Out (Read Out) Channel Contents ..	4
FIG-4: To Place the Radio in Program/ Readout Mode .....	4
<b>TABLE 1: FREQUENCY CODES</b> .....	5
<b>TABLE 2: INTERFERENCE ELIMINATOR (QUIET CALL®) TONE CODES</b> .....	5
<b>HOW TO PROGRAM "FOUR SERIES" JMX PORTABLES</b> .....	6
<b>!! CAUTIONS — ALL RADIOS !!</b> .....	7

<u>DESCRIPTION</u>	<u>PAGE</u>
<b>BATTERIES</b>	
FIG-5: Battery Access and Installation .....	8
Optional Charging Accessories .....	8
Batteries .....	9
General .....	9
Charging .....	9
Battery Maintenance and Conditioning .....	9
<b>TROUBLESHOOTING</b>	
Notes .....	10
Chart .....	10
<b>FCC LICENSE REQUIRED</b>	
FCC Regulations .....	11
Service .....	11
How to Obtain an FCC Radio License .....	11
<b>LIMITED WARRANTY</b> .....	<b>INSIDE BACK COVER</b>
<b>TABLES:</b>	
1. Programmable Frequencies and Codes .....	5
2. Quiet Call Codes and Frequencies .....	5
<b>FIGURES:</b>	
1. Belt Clip Installation .....	1
2. Radio Controls and Connectors .....	2
3. To Scan Weather Frequencies .....	3
4. To Place the Radio in Program/ Readout Mode .....	4
5. Battery Access and Installation .....	8

**NOTE:** Refer to pages *ii* and 8 for Accessory information.

# INTRODUCTION

## THANK YOU FOR CHOOSING RITRON

Congratulations on your purchase of the JMX "Four Series" radio. Your new radio is the culmination of Ritron's 25 years of designing, manufacturing, and supplying reliable, professional wireless communication products. Ritron wireless products will improve the operation, safety, and profitability of any organization by providing instant voice communications between employees throughout the workplace.

## GENERAL

This manual covers your Ritron JMX "Four Series" radio. The JMX radio is a compact, programmable two-way handheld designed to operate in a professional FM communications band (VHF/UHF). Your JMX handheld features push-button operating controls, with the Push-To-Talk (PTT) and Channel buttons on one side of the radio, and the On/Volume Up, Volume Down/Off and monitor controls on the top. It can be programmed to contain a unique set of operating frequencies and options.

Your JMX radio also features quick-change battery pack and drop-in charger capabilities. Refer to the listed Accessories options on page ii.

## MODEL IDENTIFICATION

The model number on the back of the radio case indicates its operating band. A color "dot" label on the bottom of JMX radio cases also indicates the frequency. Refer to the Frequency Table on page 5.

VHF radios are designed to operate on up to four channels within the 5 MHz band between factory standard 150 and 155 MHz.

UHF radios are designed to operate on up to four channels within the 10 MHz band between factory standard 460 and 470 MHz.

## "FOUR SERIES" MODEL NUMBERS

### VHF

#### MODEL

JMX-141	..... (Jobcom)	..... (1.5-Watt, 4 Channel)**
JMX-146XP	..... (Jobcom)	..... (2-Watt, 4 Channel)
JMX-144	..... (Jobcom)	..... (4-Watt, 4 Channel)
JMX-146	..... (Jobcom)	..... (2-Watt, 4 Channel *)

### UHF

#### MODEL

JMX-441	..... (Jobcom)	..... (1-Watt, 4 Channel)
JMX-446XP	..... (Jobcom)	..... (2-Watt, 4 Channel)
JMX-444	..... (Jobcom)	..... (3-Watt, 4 Channel)
JMX-446	..... (Jobcom)	..... (2-Watt, 4 Channel *)

The FCC permits high power operation on all MURS frequencies, red, purple, yellow, and brown dot frequencies. All other dot/star frequencies are allowed a maximum of 2 Watts.

\* JMX-146/-446 are limited to four-channel capability using table frequencies only, PC programming is not possible with these models.

\*\* New Expanded Frequency List on models manufactured after 10-30-01.

## NEW EASIER FIELD PROGRAMMING METHOD

Your new JMX "Four Series" portable radio is the result of continuous product improvement, with special attention to our customers' feedback. Each is equipped with these improved features:

- Four-channel capability,
- Allows you to select and program each channel individually with channel table frequencies and interference eliminator codes;
- Allows you to delete a selected channel.

## INSPECTION

Make sure the package includes a radio, antenna, rechargeable battery pack and belt clip. Examine the equipment immediately after delivery and report any damage to your shipping company.

## FIG-1: BELT CLIP INSTALLATION

### To attach the belt clip to the radio:

Place the clip on the back of the radio case, aligning the screw hole in the clip with the hole in the case. Tighten the screw. See FIG-1 below.

PHILLIPS  
HEAD  
SCREW

BELT  
CLIP

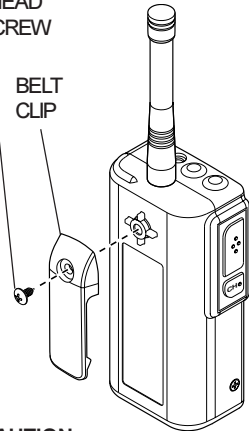

### CAUTION:

Use only the included Phillips head screw, because a longer screw could damage radio electronics.

# CONTROL & OPERATION

## 1 ANTENNA

The flexible antenna radiates and receives radio signals. Screw the antenna base all the way into the threaded bushing on top of the radio.

**NOTE:** Use only the type of antenna furnished with the radio. VHF and UHF antennas are not interchangeable.

## 2 ON/ VOLUME UP

To switch the unit On, press the On/ Volume Up button; the speaker will beep a number of times equal to the channel. Once the radio is On, press this button to increase volume.

## 3 VOLUME DOWN/ OFF

Press the Volume Down/ Off button to decrease volume. To switch Off the unit, press and hold this button until the speaker emits a double beep.

## 4 PUSH-TO-TALK SWITCH (PTT)

Press and hold the PTT when transmitting; release it to receive.

## 5 CHANNEL SELECT

Press the button once and the radio will beep a number of times equal to the current channel number. Pressing the button again will increment the channel and the radio will beep the new channel.

## 6 BATTERY ACCESS DOOR (CASE BOTTOM)

The battery access door may be removed to access the battery pack. Refer to Battery Access & Installation, FIG-5, page 8.

## 7 JACK COVER

This rubber cover seals out dust and moisture, etc. Snap the cover into the audio accessory jack and charge jack openings when the jacks are not in use.

## 8 AUDIO ACCESSORY JACK

The audio accessory jack is used to plug in earphone options, and, in conjunction with the charge jack, to connect an optional remote speaker/ microphone or a single- or dual-ear headset.

## 9 CHARGE JACK

The battery pack may be charged through this jack using the supplied RITRON charger cube. Refer to Accessories, page 1, for additional charging options.

## 10 SPEAKER

The speaker, located behind the front grille, allows you to hear calls on your channel.

## 11 MICROPHONE

The microphone allows your voice to be heard in transmissions to other radios. Speak in a normal tone; shouting does not improve your listener's reception.

## 12 DROP-IN CHARGING CAPABILITY

Two contacts, in the bottom of the radio, permit charging the battery pack with an optional drop-in charger. Refer to Optional Charging Accessories, page 8.

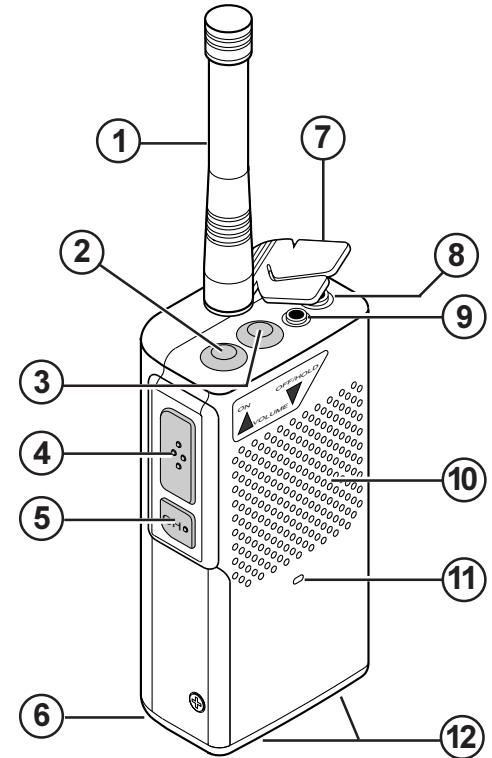

FIG-2: RADIO CONTROLS & CONNECTORS

page 2

**IMPORTANT:** CHARGE THE BATTERY PACK BEFORE using the radio for the first time. Refer to Batteries, pages 8 and 9.

www.TwoWayRadioEquipment.com | (800) 878-7829 | Sales@TwoWayRadioEquipment.com

# OPERATION

## WEATHERSCAN (VHF RADIOS ONLY)

TO SCAN STANDARD U.S. WEATHER FREQUENCIES and hear weather forecasts, follow the steps in FIG-3 below. To resume normal two-way operation, turn the radio off, then on again.

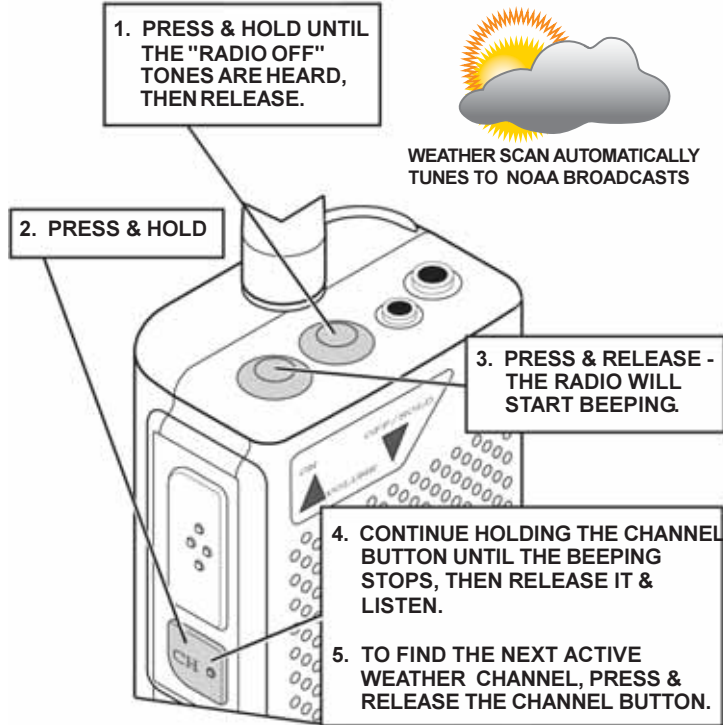

FIG-3: TO SCAN WEATHER FREQUENCIES

## WHAT THE RADIO TONES MEAN

### Power On/ Self Test "OK"

When it is first turned on, the radio runs a quick "self test" to confirm basic functions. The radio then "beeps" the number of times equal to the channel number selected.

### Error Tones

In the Program/ Readout Mode, the radio will emit an Error Tone if a programming error is made.

If the self test detects a diagnostic error, an alternating error tone sounds. Turn the radio off, then on again. Consult a Ritron Dealer, or Ritron, Inc. with any problem you cannot correct.

### Low Battery Tone

When the battery voltage has dropped below a certain level, the radio will sound a short "beep" every 20 seconds to inform you to charge the battery. JMX-146/ -446 does not have this feature.

A longer low tone will sound when the battery is completely discharged, then automatically shut off the radio. (All models).

### Channel Select Tone

When you press the channel select button, the radio "beeps" the number of times equal to the channel number selected.

### Program/ Readout Mode Tone

Placing the radio in Program/ Readout Mode causes it to beep rapidly for about three seconds, then to "triple beep." This series of beeps indicates the radio is ready for you either to program, or to read out the programmed contents. See pages 4 and 6.

### Transmitter Time-Out

A low tone will sound and the transmitter automatically shuts off if you hold down the PTT button continuously for more than 60 seconds. The radio switches to "receive."

### Quiet Call Squelch Tones

If you press both volume buttons simultaneously, a single beep indicates Quiet Call squelch is on; a "double beep" means it is off.

### QUIET CALL TONE CODES (Interference Eliminator Codes)

Tone codes filter out static, noise and reduce unwanted "chatter" on radio channels. When you operate on a frequency with a tone code, you screen out most interference. This allows you to communicate with less interference and to hear only those users in your radio group.

**IMPORTANT:** All radios in the talk group must operate on the same frequency and tone code.

# TO DETERMINE FREQUENCIES & CODES IN "FOUR SERIES" JMX

## IMPORTANT:

To talk to other users in your group, all radios must be set to the same frequency and Interference Eliminator codes.

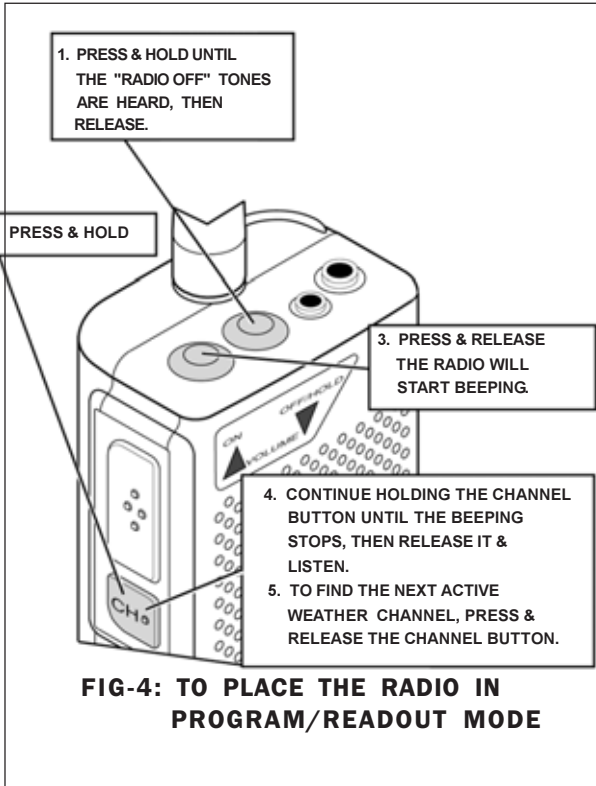

**FIG-4: TO PLACE THE RADIO IN PROGRAM/READOUT MODE**

## SELECT EACH CHANNEL TO BEEP OUT (READ OUT) CHANNEL CONTENTS:

- To enter the Programming/ Readout Mode, refer to FIG-4 at left.
- YOU MUST Press the Channel Selector button to select the channel to be read out.
- Press and release the On/ Volume Up button.  
The radio will begin to sound a series of beeps; each set in the series equals one digit of each two-digit (frequency code/interference eliminator code) code in the radio; **see Tables 1 and 2, opposite.**
- Count the beeps in each set. Write down the number of beeps for each digit in the spaces provided below.  
**EXAMPLES:** 2 beeps = 2; 10 beeps = 0 (zero).
- To read out another channel, follow steps 2 through 4. When you are finished, complete step 6.
- Turn the radio off.

**NOTES:** \* The radio pauses to sound a low tone at the end of each set of beeps, separating one digit from the next.  
◆ The radio sounds a triple beep when the readout (beep out) process is complete.

## SELECT THE CHANNEL NUMBER YOU WISH TO READ OUT:

CHANNEL:	FREQUENCY CODE:		INTERFERENCE ELIMINATOR CODE:	
CH. 1	1st digit # of beeps	* 2nd digit # of beeps	* 3rd digit # of beeps	* 4th digit # of beeps ◆
CH. 2	1st digit # of beeps	* 2nd digit # of beeps	* 3rd digit # of beeps	* 4th digit # of beeps ◆
CH. 3	1st digit # of beeps	* 2nd digit # of beeps	* 3rd digit # of beeps	* 4th digit # of beeps ◆
CH. 4	1st digit # of beeps	* 2nd digit # of beeps	* 3rd digit # of beeps	* 4th digit # of beeps ◆

- NOTES:** a. Ten (10) beeps = 0 (zero).  
b. The radio will beep out "44" as an interference eliminator code if it was programmed for "No Tone."  
c. If a radio is PC-programmed with any frequency or tone not listed in Table 1 or 2 on page 5, the radio will sound the error tone on contents "beepout."

# FREQUENCY CODES

**TABLE 1: PROGRAMMABLE FREQUENCY CODES**

JMX BEEP OUT/ PTT CLICK FREQ. CODE	VHF Business Band			JMX BEEP OUT/ PTT CLICK FREQ. CODE	UHF Business Band		
	MHz	Frequency	Color		MHz	Frequency	Color
01	154.600	Green Dot		01	467.7625	J	
02	154.570	Blue Dot		02	467.8125		
03	151.625	Red Dot *		03	464.5500	Yellow Dot *	
04	151.955	Purple Dot		04	464.5000	Brown Dot *	
05	151.925			05	467.8500	Silver Star	
06	154.540			06	467.8750	Gold Star	
07	154.515			07	467.9000	Red Star	
08	154.655			08	467.9250	Blue Star	
09	151.685			09	469.2625		
10	151.715			10	462.5750	White Dot	
11	151.775			11	462.6250	Black Dot	
12	151.805			12	462.6750	Orange Dot	
13	151.835			13	464.3250		
14	151.895			14	464.8250		
15	154.490			15	469.5000		
16	151.655			16	469.5500		
17	151.745			17	463.2625		
18	151.865			18	464.9125		
19	151.820	MURS †		19	464.6000		
20	151.880	MURS †		20	464.7000		
21	151.940	MURS †		21	462.7250 ††		
00	DELETE Code ∨			00	DELETE Code ∨		

† Not available on JMX-146 model  
 ∨ 2-digit Frequency placeholder code  
 (Refer to "delete a channel" on page 6, item f.)

†† Not available on JMX-446 model  
 \* Itinerant frequency

**NOTES:**

1. Programming ten (10) PTT clicks = the digit 0 (zero); hearing (10) ten beeps on readout = the digit 0 (zero).
2. To delete a channel, all four placeholders must be programmed with "0" (zero)
3. When a channel is deleted, the remaining channels stay in the same channel order. When you press the Channel Button, the radio will skip the deleted channels.

# INTERFERENCE ELIMINATOR (QUIET CALL®) TONE CODES

**TABLE 2: PROGRAMMABLE TONE CODES**

JMX BEEP OUT/ PTT CLICK CODE	Freq. (Hz)	Other Radio Brands		JMX BEEP OUT/ PTT CLICK CODE	Freq. (Hz)	Other Radio Brands	
		Tone Code	Freq. (Hz)			Tone Code	Freq. (Hz)
01	67.0	XZ	67.0	27	167.9	6Z	167.9
02	71.9	XA	71.9	28	173.8	6A	173.8
03	74.4	WA	74.4	29	179.9	6B	179.9
04	77.0	XB	77.0	30	186.2	7Z	186.2
05	79.7	SP	79.7	31	192.8	7A	192.8
06	82.5	YZ	82.5	32	203.5	M1	203.5
07	85.4	YA	85.4	33	210.7	--	210.7
08	88.5	YB	88.5	34	218.1	--	218.1
09	91.5	ZZ	91.5	35	225.7	--	225.7
10	94.8	ZA	94.8	36	233.6	--	233.6
11	97.4	ZB	97.4	37	241.8	--	241.8
12	100.0	1Z	100.0	38	250.3	--	250.3
13	103.5	1A	103.5	39	69.4	--	69.4
14	107.2	1B	107.2	40	159.8	--	159.8
15	110.9	2Z	110.9	41	165.5	--	165.5
16	114.8	2A	114.8	42	171.3	--	171.3
17	118.8	2B	118.8	43	177.3	--	177.3
18	123.0	3Z	123.0	44**	No Tone	--	No Tone
19	127.3	3A	127.3	45	183.5	--	183.5
20	131.8	3B	131.8	46	189.9	--	189.9
21	136.5	4Z	136.5	47	196.6	--	196.6
22	141.3	4A	141.3	48	199.5	--	199.5
23	146.2	4B	146.2	49	206.5	--	206.5
24	151.4	5Z	151.4	50	229.1	--	229.1
25	156.7	5A	156.7	51	254.1	--	254.1
26	162.2	5B	162.2	00	DELETE Code ∨		

\*\* Refer to Note 2 on both pages 4 & 6.

∨∨ 2-digit Interference Eliminator placeholder code  
 (Refer to "delete a channel" on page 6, item f.)



# HOW TO PROGRAM "FOUR SERIES" JMX PORTABLES

To match other radios, the owner can select FREQUENCY and INTERFERENCE ELIMINATOR TONE CODES from **Tables 1 and 2 on page 5**.

1. Choose your frequency codes (Table 1), and interference eliminator codes (Table 2). **Note that each code consists of two digits.** Write down the number of PTT clicks to program each channel frequency in the spaces provided below.

## SELECT THE CHANNEL NUMBER YOU WISH TO PROGRAM:

CHANNEL:	FREQUENCY CODE:		INTERFERENCE ELIMINATOR CODE:	
CH. 1	_____* 1st digit # of PTT clicks	_____* 2nd digit # of PTT clicks	_____* 3rd digit # of PTT clicks	_____* 4th digit # of PTT clicks
CH. 2	_____* 1st digit # of PTT clicks	_____* 2nd digit # of PTT clicks	_____* 3rd digit # of PTT clicks	_____* 4th digit # of PTT clicks
CH. 3	_____* 1st digit # of PTT clicks	_____* 2nd digit # of PTT clicks	_____* 3rd digit # of PTT clicks	_____* 4th digit # of PTT clicks
CH. 4	_____* 1st digit # of PTT clicks	_____* 2nd digit # of PTT clicks	_____* 3rd digit # of PTT clicks	_____* 4th digit # of PTT clicks

\* The radio pauses to sound a low tone at the end of each set of beeps, separating one digit from the next.

2. Follow the instructions in FIG-4 on page 4 to place the radio in the Program/ Readout Mode.
3. **YOU MUST** press the Channel Selector button to select the channel to be programmed.
4. Enter codes in the sequence shown in Step 1 by clicking the PTT the number of times equal to each digit of the code.  
**EXAMPLE:** Code "04": Click the PTT ten times to program "0", pause—the radio sounds a low tone. Click the PTT four times to program "4", pause—the radio sounds a low tone.
5. When all digits are programmed, press and release On/ Volume Up to save your programming. **The radio sounds a triple beep.**  
**NOTE:** An error tone will sound if you attempt to save an incorrect digit. Turn the radio OFF, check the digits you are attempting to enter, then start over at Step 2.
6. To program another channel, repeat steps 3 through 5. When you are finished programming, complete step 7.
7. Turn the radio OFF and then ON again—the radio is now ready to use.

- NOTES:**
- a. Ten (10) PTT clicks = 0 (zero).
  - b. **YOU MUST** enter "44" to enter "No Code" interference eliminator to match radios not having tone codes. Refer to Table 2 on page 5.
  - c. IF YOU MAKE A PTT CLICK ERROR, turn the radio OFF then ON, and start over.
  - d. If the radio does not sound a confirming triple tone when you attempt to enter Program/ Readout Mode, the radio was factory or dealer customized to disable programming. Consult the radio owner or your dealer.
  - e. Refer to Frequency and Interference Eliminator Tone Code tables on page 5.
  - f. To delete a channel, follow steps 2 and 3 above, then enter "0" (zero = 10 PTT clicks) for each of the four digit locations. Remaining channels are in the same sequence, and the Channel Selector will skip over the deleted channel number.

# !! CAUTIONS — ALL RADIOS !!

---

## **OBSERVE CAUTION IN THE FOLLOWING ENVIRONMENTS TO MAXIMIZE THE LIFE OF YOUR RADIO EQUIPMENT:**

**MOISTURE:** JMX Series radios are not waterproof. DO NOT directly expose them to rain or excessive moisture.

**CHEMICALS:** Detergents, alcohol, aerosol sprays or petroleum products can damage the radio case. DO NOT use petroleum solvents of any kind; use a soft cloth moistened with water to clean the case.

**EXTREME HEAT:** High temperatures can damage the battery and other components. DO NOT expose the units to extreme heat or leave them in direct sunlight.

**LOW TEMPERATURES:** The capacity of the NiCd battery is greatly reduced in extreme cold. When using the unit in very cold environments, periodically warm the radio under your coat.

**EXCESSIVE TRANSMISSIONS:** Maximum drain on battery power occurs when you are transmitting. DO NOT hold the Push-To-Talk switch down longer than necessary during transmission intervals. DO NOT reduce battery service life by attempting to power a radio with a depleted battery; always charge batteries overnight after each day of use.

**VIBRATION/ SHOCK:** Although your JMX Series radio is designed to be rugged, it will not survive excessive abuse. Avoid dropping the radio.

**NOTE:** The optional MH-A holster provides added protection from weather and shock.

## **EXPOSURE TO RADIO FREQUENCY ENERGY:**

The JMX/SST Series handheld radios generate RF electromagnetic energy during transmit mode. The transmit mode is active when the PTT switch is depressed. This radio is designed for, and classified as, "Occupational Use Only", meaning that it must be used only during the course of employment by individuals who are aware of the hazards and the ways to minimize such hazards. This series of radios is NOT intended for use by the "General Population" in an uncontrolled environment.

When used as directed, this series of radios is designed to comply with the FCC's RF exposure limits for "Occupational Use Only". In addition, they are designed to comply with the following Standards and Guidelines:

- FCC OET Bulletin 65, Edition 97-01, Supplement C, Evaluating Compliance with FCC Guidelines for Human Exposure to Radio Frequency Electromagnetic Fields.
- American National Standards Institute (C95.1-1992), IEEE Standard for Safety Levels with Respect to Human Exposure to Radio Frequency Electromagnetic Fields, 3 kHz to 300 GHz.
- American National Standards Institute (C95.3-1992), IEEE Recommended Practice for the Measurement of Potentially Hazardous Electromagnetic Fields-RF and Microwave.

To ensure that exposure to RF electromagnetic energy is within the FCC allowable limits for occupational use, always adhere to the following guidelines:

- Use only the antenna(s) available from RITRON for these models. **DO NOT** attempt to substitute any other antenna. **DO NOT** operate the radio without an antenna.
- Keep talk times as short and infrequent as possible. **DO NOT** depress the PTT button when not actually wishing to transmit. These radios are equipped with an internal timer to limit continuous transmit times. **DO NOT** exceed a 50% transmit duty cycle.
- When transmitting, hold the radio in front of the mouth at a distance of at least 4 inches. **DO NOT** hold the radio in such a manner that the antenna is next to, or touching, exposed parts of the body, especially the face or eyes while transmitting.
- In belt mounted applications, when transmitting, remove the radio from the belt and hold away from the body at least 4 inches.
- When using external headset accessories, hold the unit away from the body at least 4 inches while transmitting.
- **DO NOT** allow children to operate the radio.

# BATTERIES

**FIG-5: BATTERY ACCESS & INSTALLATION:**

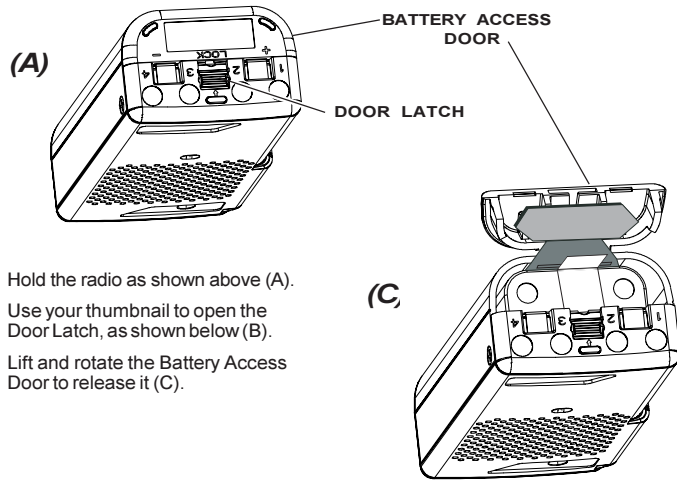

1. Hold the radio as shown above (A).
2. Use your thumbnail to open the Door Latch, as shown below (B).
3. Lift and rotate the Battery Access Door to release it (C).

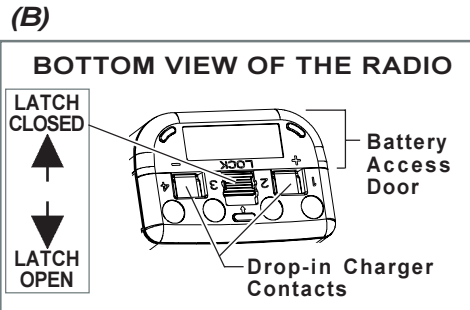

4. Use the Pull-tab to pull the battery pack out of the case (D).
5. Insert the replacement battery pack, being certain to POSITION IT RELATIVE TO THE CASE AS SHOWN IN (D). Push the Battery Pack in as far as possible.
6. Replace the Battery Access Door. Secure it by closing the Door Latch as shown in (B).
7. Be certain to firmly lock the Door Latch, as shown in (B).

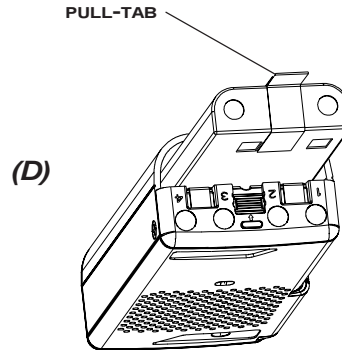

## OPTIONAL CHARGING ACCESSORIES:

Spare/ Replacement Battery Pack



Drop-in Battery Charger with spacer

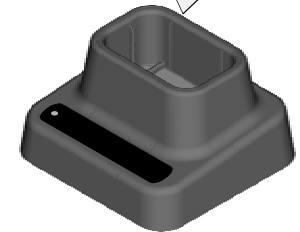

### JOB COM JMX Accessories:

BPJS-6N .....	700 mAH Spare Battery Pack
BPS-6N-SC .....	800 mAH Spare Battery Pack
BPS-6N-MH .....	1500 mAH Spare Battery Pack
BPJS-AD .....	Drop-in Charger Adapter
BCJS-4AD .....	4-Unit Gang Charger

*See Accessories on page ii.*

# BATTERIES

**CAUTION:** Use only RITRON-supplied chargers; using other chargers may cause fire or explosion, or otherwise damage the radio.

## GENERAL

The JMX Series radio is powered by a rechargeable battery pack.

## CHARGING

Because the battery pack loses its charge during storage and shipment, fully charge it before first use. To ensure peak radio performance for the next day, charge the battery overnight after each day of use. It completely charges in about ten hours.

### To charge the battery with a RITRON cube charger

Plug the charger cord into the charge jack (marked "CHG") on top of the radio. Then plug the cube into an 110 VAC outlet. The green lamp lights while the battery is charging, and should go out only when the cube or cord is unplugged.

### To charge the battery with a RITRON drop-in charger

Two charger contacts, visible through the radio case bottom, permit charging the battery with an optional Ritron drop-in charger. The battery pack may be either removed from the radio case for charging, or charged inside the radio case.

Each drop-in charger comes with a spacer to permit charging a "spare" battery while the radio is being used.

To use the drop-in charger, plug it into a 110 VAC outlet. Set either the radio with the battery installed, or only the battery with the battery spacer, into the charger. Refer to the illustration in Optional Accessories, opposite. Each battery contact must rest on a charger contact pin.

## NOTE:

**Battery pack life averages one year. Follow these guidelines to maximize service life:**

- CONDITION battery packs once a month as directed in Battery Maintenance & Conditioning, at right.
- CONDITION batteries that are run down.
- CHARGE batteries for 16 hours before storage, and for 16 hours once a month thereafter.
- DO NOT overcharge batteries. Unplug the cube charger after 16 hours to avoid overcharging.
- DO NOT charge batteries in temperatures colder than about 45°F. Charging batteries in temperatures above 95°C. does not harm them, but can reduce charge capacity.

## BATTERY MAINTENANCE & CONDITIONING

Due to the extended run time of the JMX Series radios, some users may never fully discharge the NiCad battery pack during normal use. Achieve maximum battery life by fully discharging the battery periodically to condition it.

After exposing the battery pack to many cycles of not fully discharging it before recharging, the radio may exhibit reduced battery capacity. This reduced capacity is evident when, after several hours of use, battery voltage drops while the radio is transmitting, causing the radio to emit a dead battery warning tone and shut itself off.

Condition battery packs by the following procedure as either a preventive measure, or if you suspect reduced capacity:

### TO CONDITION THE BATTERY PACK:

1. Use your radio throughout a normal work day without charging.
2. • Press and hold the On/ Volume Up and Volume Down/ Off buttons simultaneously for 8 seconds to place the radio in "open squelch" mode.
  - Release both buttons when you hear the radio beep rapidly; it will then emit a loud "rushing" noise. Press On/ Volume Up to maximize this noise.
3. • Put the radio away in a secure place (possibly a desk drawer), where nothing can press against the buttons to accidentally turn it off or cause it to transmit. Allow the radio to run until it shuts off when the battery is completely discharged. A typical battery pack may require about 8 hours to completely discharge.
4. • When the radio has shut off, charge it overnight for 12-14 hours. The battery will be ready for use with renewed capacity.

**NOTE:** A new battery must be charged and discharged several times before it can reach its maximum charge capacity.

# TROUBLESHOOTING

## NOTES

- Try a battery pack from a working radio. If the radio in question works with that pack, the original battery is suspect.
  - Charge the suspect battery as recommended in this manual. If this original battery cannot power the radio, try charging it again with another charger. If the battery still doesn't hold a charge, the pack should probably be replaced.
  - If the battery appears to be "good" after using the second charger, the first charger may be faulty. Contact a dealer or Ritron about an accessory that is not operating properly.
- Reception can often be improved if you relocate by a short distance. This effect is more noticeable inside buildings.
  - The range for JMW/ SST radios is about two miles, line-of-sight.
- If your radio does not detect calls from other radios on the channel, turn off Quiet Call by pressing and holding both volume buttons at the same time—a double beep indicates Quiet Call is off.
- Without use of a repeater: To hear a call, select a channel programmed to receive the caller's transmit frequency. To call another unit, select a channel programmed to transmit the other radio's receive frequency.
  - Using a repeater: A radio channel can hold two separate operating frequencies, one for receive and one for transmit. Your channel must work with the repeater's transmit and receive frequencies.
- Maximum power drain occurs when the radio transmits, so don't hold down the PTT more than needed to transmit.
  - Battery power is used while the handheld is left on to receive calls. If practical, switch off the unit.
- Battery capacity is greatly reduced in extreme cold.
  - To use the radio in very cold weather, periodically warm it under your coat if possible.
  - An optional remote speaker/ microphone allows keeping the radio under your coat while transmitting and receiving.
- To "talk" with each other, radios must be programmed identically for Quiet Call code, as well as frequency. Each code is unique; radios respond only to the code programmed.
  - Press and hold both volume buttons at the same time.
    - A single beep indicates Quiet Call squelch is on.
    - A double beep indicates Quiet Call squelch is off.

## CHART

If you have trouble operating the handheld, review the Control & Operation, pages 2 and 3. If you think the radio is malfunctioning, check the list below.

Problem	Possible Solutions
<b>GENERAL</b>	
The radio does not work at all.	Make sure that the battery is installed correctly, as shown in FIG-5. page 8. Recharge or replace the battery. (See pages 8 & 9.)
Operating features do not work exactly as expected.	The radio has been dealer programmed for customized operation. (Consult dealer.)
Reception is poor.	Move to a different location. (See Note 2.) Confirm the proper antenna is connected to the radio. (See page 2, "Antenna.")
You cannot hear calls from other radios.	Turn off Quiet Call (coded) squelch. (See Note 3.) Ensure radio receives on the same frequency as the caller transmits. (See Note 4.) Recharge the battery. (See Note 1.)
Your calls cannot be heard in other radios.	Make sure that your radio transmits on the receive frequency of the radio(s) you want to call. (See Note 4.) Recharge the battery.
<b>BATTERY</b>	
Battery loses charge sooner than expected.	Review battery charging instructions, page 9. Conserve the battery. (See Note 5.) If the radio is used in extreme cold, warm the radio under your coat. (See Note 6.) Replace the battery; see FIG-5, page 8. (See Note 1.)
<b>ERROR TONES</b>	
An error tone sounds when the radio is first switched on.	See "Error Tones" on page 3.
An error tone occurs while transmitting.	Refer to "Transmitter Time-Out," page 3.
<b>QUIET CALL</b>	
You cannot screen out calls from users outside of your Quiet Call group.	Make sure that the channel is programmed with Quiet Call. Activate coded squelch. (See Note 7.)
You cannot hear Quiet Call messages while in Quiet Call (coded) squelch.	Confirm that the channel is programmed to detect the same code as the calling radio(s) transmits. (See Note 7.)
Others in your Quiet Call group cannot hear your Quiet Call messages.	Verify that you transmit the same code as the radio(s) you call are programmed to detect. (See Note 7.)

# FCC LICENSE REQUIRED

## FCC REGULATIONS

### LICENSING —

The FCC requires the owners of the radios to obtain a station license before using them.

The station licensee is responsible for ensuring that transmitter power, frequency and deviation are within the limits specified by the station license. The station licensee is also responsible for proper operation and maintenance of the radio equipment. This includes checking the transmitter frequency and deviation periodically, using appropriate methods.

To get a FCC license for VHF or UHF frequencies, submit FCC application Form 600 as indicated in the block at right. Your Ritron dealer can help you with this process.

### SAFETY STANDARDS —

The FCC (with its action in General Docket 79-144, March 13, 1985) has adopted a safety standard for human exposure to radio frequency electromagnetic energy emitted by FCC regulated equipment. Ritron observes these guidelines and recommends that you do also:

- DO NOT hold the radio so that the antenna is very close to or touching exposed parts of the body, especially the face or eyes, while transmitting. Keep the radio vertical, four inches away while talking into the front panel.
- DO NOT press the Push-To-Talk except when you intend to transmit.
- DO NOT operate radio equipment near electrical blasting caps or in an explosive atmosphere.
- DO NOT allow children to play with any radio equipment that contains a transmitting device.
- Repair of Ritron products should be performed only by Ritron authorized personnel.

## SERVICE

Federal law prohibits you from making any internal adjustments to the transmitter, and/ or from changing transmit frequencies unless you are specifically designated by the licensee.

If your radio equipment fails to operate properly, or you wish to have the radio programmed, contact your authorized dealer or Ritron.

## HOW TO OBTAIN AN FCC RADIO LICENSE

### Federal Communications Commission (FCC) Licensing Information

Because your Ritron radio operates on Private Land Mobile frequencies, it is subject to the Rules and Regulations of the FCC, which requires all operators of these frequencies to obtain a station license before operating their equipment. Make application for your FCC license on FCC Forms 600 and 159.

*To have forms and instructions faxed to you by the FCC, call the **FCC Fax-On-Demand** system at **202-418-0177** from your fax machine; request Document 000600 & Form 159.*

*To have Document 000600 & Form 159 mailed to you, call the **FCC Forms Hotline** at **800-418-FORM** (800-418-3676).*

*For help with questions concerning the license application, contact the FCC at **888-CALL-FCC** (888-225-5322).*

*You must decide which radio frequency(ies) you can operate on before filling out your application; refer to Table 1 on page 5 of this manual. For help determining your frequencies, call Ritron at **800-USA-1-USA** (800-872-1872).*

# RITRON, INC. LIMITED WARRANTY

## WHAT THIS WARRANTY COVERS

RITRON, INC. ("RITRON") provides the following warranty against defects in materials and/or workmanship in **RITRON Radios, Rechargeable Batteries and Accessories** under normal use and service during the applicable warranty period (as stated below). "Accessories" means antennas, holsters, chargers, earphones, speaker/microphones and items contained in the programming and programming/service kits. Rechargeable batteries will be replaced during the applicable warranty period only if leakage occurs or the batteries drop below 75% of rated capacity.

<u>WHAT IS COVERED</u>	<u>FOR HOW LONG</u>	<u>WHAT RITRON WILL DO</u>
Portable JMX Radios	1 year *	During the first year after date of purchase, Series RITRON will repair or replace the defective product, at RITRON's option, parts and labor included at no charge.
RITRON Rechargeable Batteries	1 year *	RITRON will replace the defective battery
Accessories	90 days *	<i>* After date of purchase</i>

## WHAT THIS WARRANTY DOES NOT COVER:

- Any technical information provided with the covered product or any other RITRON products;
- Installation, maintenance or service of the product, unless this is covered by a separate written agreement with RITRON;
- Any products not furnished by RITRON which are attached or used with the covered product, or defects or damage from the use of the covered product with equipment that is not covered (such as defects or damage from the charging or use of batteries other than with covered product);
- Defects or damage, including broken antennas, resulting from:
  - misuse, abuse, improper maintenance, alteration, modification, neglect, accident or act of God,
  - the use of covered products other than in normal and customary manner or,
  - improper testing or installation;
- Defects or damages from unauthorized disassembly, repair or modification, or where unauthorized disassembly, repair or modification prevents inspection and testing necessary to validate warranty claims;
- Defects or damages in which the serial number has been removed, altered or defaced.
- Batteries if any of the seals are not intact.

**IMPORTANT:** This warranty sets forth the full extent of RITRON's express responsibilities regarding the covered products, and is given in lieu of all other express warranties. What RITRON has agreed to do above is your sole and exclusive remedy. No person is authorized to make any other warranty to you on behalf of RITRON. Warranties implied by state law, such as implied warranties of merchantability and fitness for a particular purpose, are limited to the duration of this limited warranty as it applies to the covered product. Incidental and consequential damages are not recoverable under this warranty (this includes loss of use or time, inconvenience, business interruption, commercial loss, lost profits or savings). **Some states do not allow the exclusion or limitation of incidental or consequential damages, or limitation on how long an implied warranty lasts, so the above limitations or exclusions may not apply to you. Because each covered product system is unique, RITRON disclaims liability for range, coverage, or operation of the system as a whole under this warranty.**

## WHO IS COVERED BY THIS WARRANTY

This warranty is given only to the purchaser or lessee of covered products when acquired for use, not resale. This warranty is not assignable or transferable.

## HOW TO GET WARRANTY SERVICE

To receive warranty service, you MUST deliver or send the defective product, delivery costs and insurance prepaid, within the applicable warranty period, to RITRON, INC., 505 West Carmel Drive, Carmel, Indiana 46032, Attention: Warranty Department.

Please point out the nature of the defect in as much detail as you can. **You MUST retain your sales or lease receipt (or other written evidence of the date of purchase) and deliver it along with the product.** If RITRON chooses to repair or replace a defective product, RITRON may replace the product or any part or component with reconditioned product, parts or components. Replacements are covered for the balance of the original applicable warranty period. All replaced covered products, parts or components become RITRON's property.

## RIGHTS TO SOFTWARE RETAINED

Title and all rights or licenses to patents, copyrights, trademarks and trade secrets in any RITRON software contained in covered products are and shall remain in RITRON. RITRON nevertheless grants you a limited non-exclusive, transferable right to use the RITRON software only in conjunction with covered products. No other license or right to the RITRON software is granted or permitted.

## YOUR RIGHTS UNDER STATE LAW

This warranty gives you specific legal rights, and you may also have other rights which vary from state to state.

## WHERE THIS WARRANTY IS VALID

This warranty is valid only within the United States, the District of Columbia and Puerto Rico.

# RITRON® *We Build Wireless Solutions*

Designed to work as an integrated system or as an add-on to virtually any existing two-way radio system



Quick Talk Alert for Remote Monitoring of any sensor or switch



Quick Talk OutPost XT  
Ruggedized Two-Way Callbox



Quick Talk OutPost  
Basic Two-Way Callbox



Quick Assist  
Push-Button RF Transmitter

Battery-operated callboxes provide instant wireless communication over existing two-way radio systems